

PT-Link II BACnet® Technical Guide

VCB-X Controller Code: SS1051 Version 2.0
 VCM-X Controller Code: SS1026 & Y200920 Version 2.0 and up;
 VCM-X Modular Controller Code: SS1030 & SS1034
 VCM-X WSHP Controller Code: SS1032 & SS1033
 SA Controller Code: Y200921
 VCM Controller Code: SS1016, Y200409, Y200616, Y200822



Table of Contents

General Information.....	3
Data Sharing	3
Scheduling.....	3
Hardware Specifications	3
System Requirements.....	3
Dimensions and Components	4
Quick Guide.....	4
Connection and Wiring Information	5
Configuring the PT-Link II Controller.....	6
PT-Link II Hardware Connection	6
Computer IP Address Set-up for Windows NT & XP	7
Computer IP Address Set-up for Windows Vista & 7	8
Configuring the PT-Link DIP Switches	9
Connecting to the PT-Link II.....	10
Making Changes to the Configuration File (config.csv).....	12
Downloading Config.csv to the PT-Link II.....	13
Troubleshooting the PT-Link II Controller.....	14
Addressing WattMaster Devices in a BACnet® Network.....	14
PT-Link II Board LEDs.....	15
OE368-23B-BACnet - ProtoCessor Module LEDs	16
OE368-23-BACnet - ProtoCessor Module LEDs.....	17
Troubleshooting Using RUINET	18
Verifying Proper Communications	18
Verifying Proper Values.....	18
Updating the PT-Link II Controller.....	19
Data Arrays	23
Table 3: VCB-X Modular Data Array for Field Server	23
Table 4: VCM-X Modular Data Array for Field Server.....	23
Table 5: VCM-X WSHP (Tulsa) Data Array for Field Server.....	24
Table 6: VCM-X WSHP (Coil) Data Array for Field Server	24
Table 7: VCM-X Data Array for Field Server.....	25
Table 8: SA Controller Data Array for Field Server.....	25
Table 9: VCM Data Array For Field Server	26
Appendix A - RJ-45 8P8C Cable for WattMaster Cross Over Networking - WattMaster Part #HZ000136.....	27
Appendix B - ProtoCessor Driver - (PICS) BACnet Protocol Implementation Conformance Statement.....	28
Appendix C - Bank A - Node ID/Device Instance DIP Switch Settings	30
Appendix D - VCB-X BACnet Parameters	33
Appendix E - VCM-X Modular and VCM-X WSHP BACnet Parameters	40
Appendix F - VCM-X BACnet Parameters	42
Appendix G - SA Controller BACnet Parameters	48
Appendix H - VCM BACnet Parameters.....	52

WattMaster Controls, Inc.
8500 NW River Park Drive · Parkville, MO 64152
Toll Free Phone: 866-918-1100
PH: (816) 505-1100 · FAX: (816) 505-1101 · E-mail: mail@wattmaster.com
Visit our web site at www.orioncontrols.com
Form: OR-PTLNK2BTL-TGD-01E Copyright January 2012 WattMaster Controls, Inc.
BACnet® is a registered trademark of ASHRAE Inc., Atlanta, GA.
WattMaster Controls, Inc. assumes no responsibility for errors or omissions.
This document is subject to change without notice.

The OE368-23B-BACNET2, PT-Link II BACnet® provides bi-directional communication between your BACnet® MS/TP protocol network and up to four* of any of the following types of Orion controllers—VCB-X, VCM-X, SA, VCM, MUA II, or VAV/CAV:

VCB-X Controller (SS1051)

VCM-X Controller (SS1026, SS1030, SS1032, SS1033, SS1034, Y200920)

SA Controller (Y200921)

VCM Controller (SS1016, Y200409, Y200616, Y200822)

**MUA II Controller (Y200405); VAV/CAV Controller (Y200301)

To determine what controller you have, you must look at the label located on the controller EPROM. If the controller label does not match any of the SS or Y numbers listed above, your controller will not work with the PT-Link II BACnet®.

*NOTE: The PT-Link II BACnet® device can be used to connect to four Orion controllers. If more than four Orion controllers are present in a system, you will need one or more additional PT-Link II BACnet® devices for integration with a BACnet® protocol network.

**NOTE: Documentation is available for MUA II/VAV/CAV on our Orion Controls website: www.orioncontrols.com/literature-new.html

Data Sharing

The PT-Link II BACnet® interface provides the following data sharing capabilities:

- Provides values from points on the Orion side of the gateway to BACnet® devices as if the values were originating from BACnet® objects.
- Allows BACnet® devices to modify point values on the Orion controller side of the PT-Link II BACnet® by using standard BACnet® write services.

Scheduling

- Ability to allow BACnet® devices to send Schedule events to the Orion controller side of the gateway by using standard BACnet® services.

Hardware Specifications

Table 1 contains the hardware specifications for the PT-Link II BACnet® interface.

Technical Data	
BACnet®-MS/TP Loop	9600, 19200, 38400, 76800 Mbps
Controller Loop	RS-485, 9600 Baud Rate
Network Protocol	BACnet®
Protocol (WattMaster Loop)	HSI Open Protocol Token Passing
Power Input Voltage	24 VAC
Power Consumption	10 VA Maximum
Operating Temp	-30°F to 150°F
Operating Humidity	90% RH Non-Condensing
Weight	4.5 oz.

Table 1: PT-Link II BACnet® Interface Technical Data

System Requirements

- The PT-Link II BACnet® interface is packaged and assembled as surface mount. Surface mount components are included for your convenience.
- Computer running Microsoft Windows™ operating system.
- Ethernet Crossover Cable (supplied).
- PT-Link II BACnet software—located on included CD-ROM and downloadable from www.orioncontrols.com/software-new.html.
- * RUIINET software— located on included CD-ROM and downloadable from www.orioncontrols.com/software-new.html.

*NOTE: RUIINET is only needed for initial configuration if you need to set the address above 255 or if your BACnet lacks DIP switches. The config.csv file's Server_DIP parameter is initially set to Enabled which allows the System_Node_ID (BACnet MAC Address) and Node_ID (Device Instance) to be set using the DIP Switches on the module.

Setting Up Your PT-Link II

Quick Guide

The following steps will get you up and running in no time:

1. Familiarize yourself with the PT-Link II components (**Figure 1**).
2. Connect your PT-Link II to the Controller(s) on your system (up to four) and connect your PT-Link II to the BACnet Network (**Figure 2**).
3. If the BACnet address doesn't need to be any higher than 255, then you can use the DIP switch settings to configure your PT-Link II. Skip to **page 9**. Set the DIP Switches, wait 4 minutes, and you'll be up and running. If the address needs to be higher than 255, or your BACnet module does not have DIP switches, continue with **Step 4**.
4. Copy the contents of the PT Link II CD to your PC's Desktop. You can also download the files from <http://orioncontrols.com/software-new.html> under PT-Link II Setup Files. These files include RUIINET.
5. Connect your PT-Link II to your computer using an Ethernet connection (**Figures 3 & 4**).
6. Change your PC's IP Address. Follow the directions that match your current operating system - Windows NT, XP, Vista, or 7. See directions on **pages 7 & 8**.
7. Obtain the following from your Building Automation System Integrator: the BACnet MAC address (System Node ID), your server's baud rate, and the Client Node ID.
8. Using RUIINET, edit the Config.csv file and verify PT Link II communications. Follow the directions on **pages 10-13**.
9. If you run into any problems, follow the instructions in the Troubleshooting section starting on **page 14** of this guide.

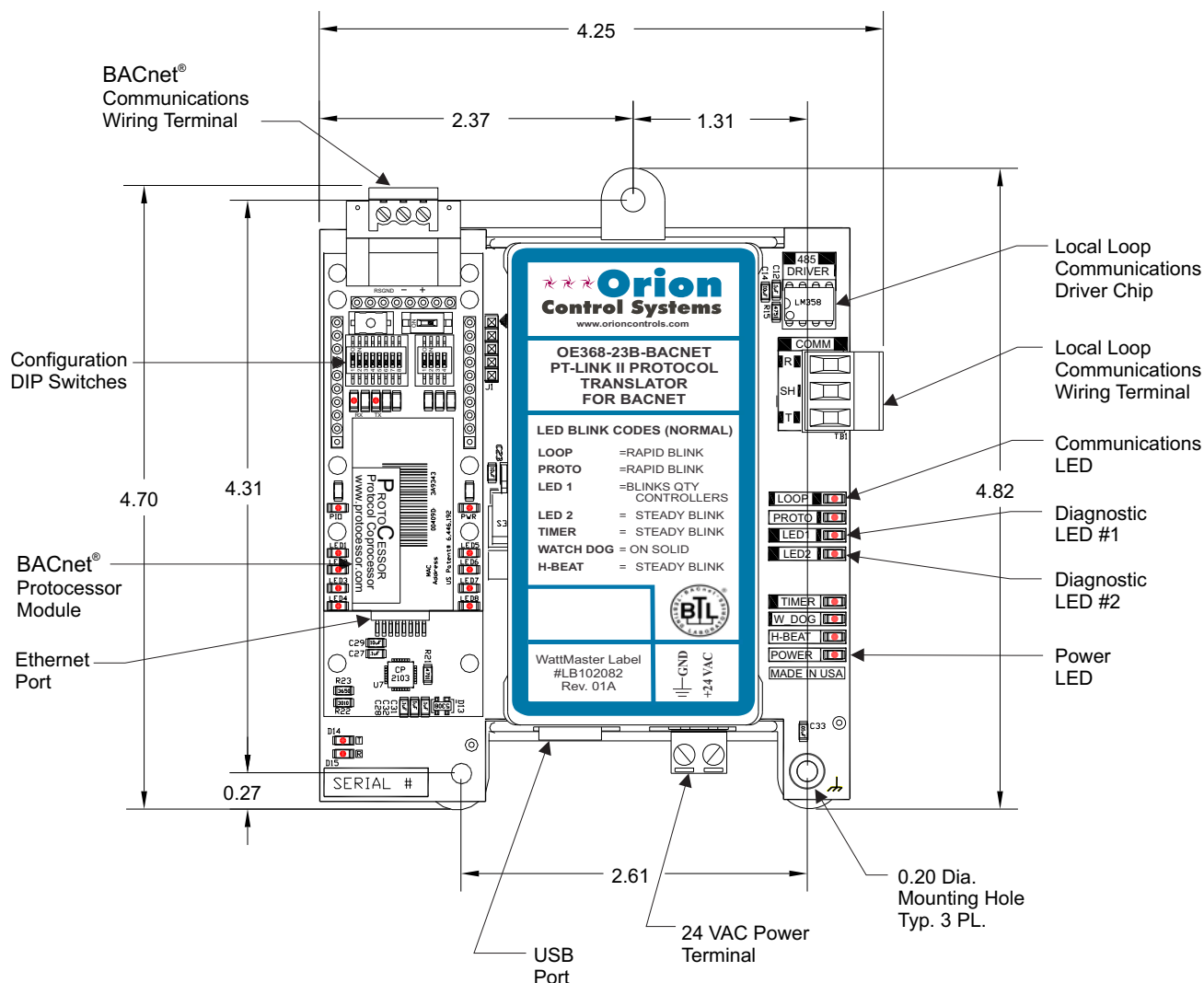

Figure 1: PT-Link II BACnet® Dimensions and Components

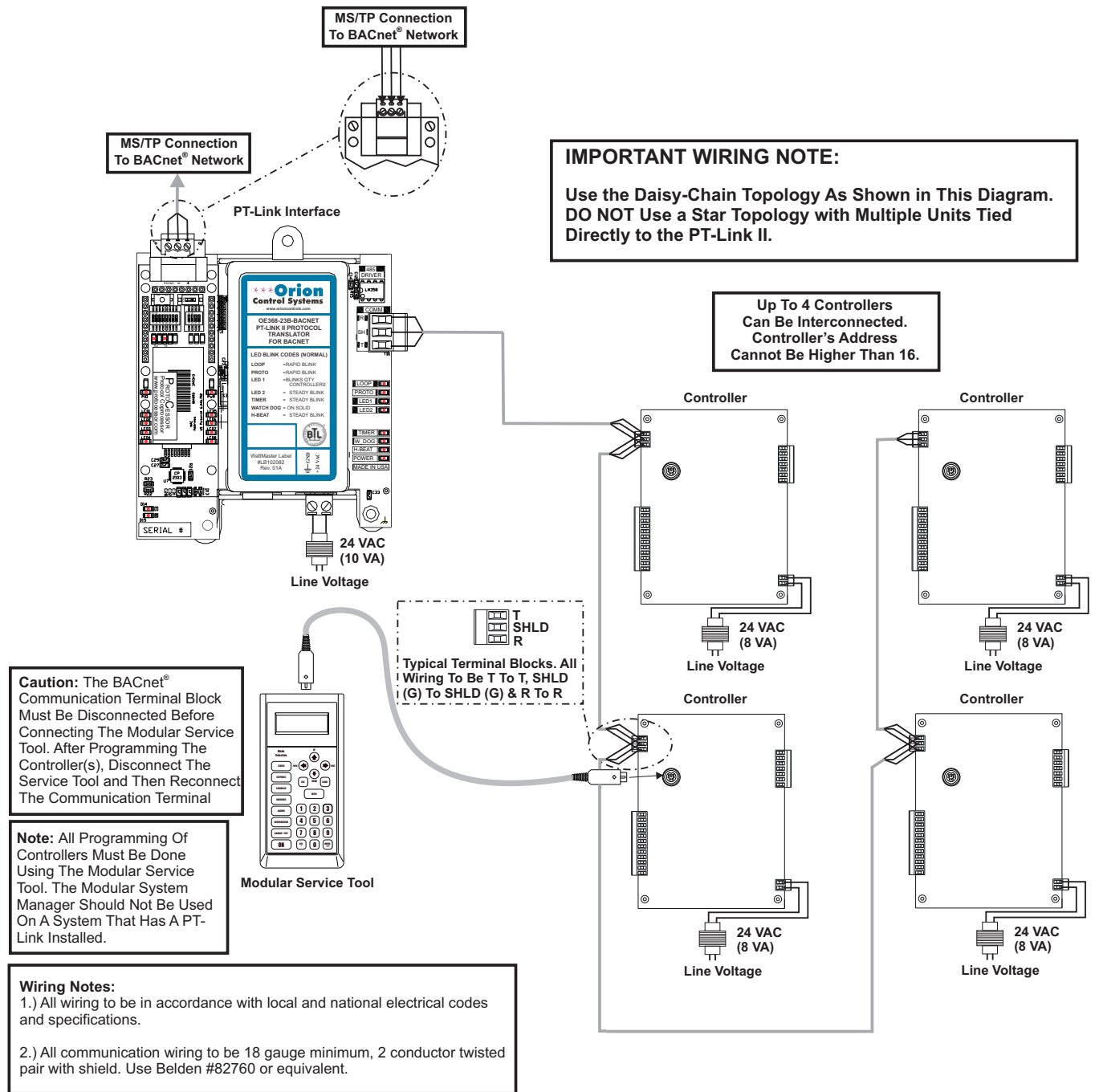

Figure 2: PT-Link II BACnet® Interface Wiring

PT-Link II Ethernet Connection

PT-Link II Hardware Connection

You have two options for connecting the PT-Link II to your PC via Ethernet:

- 1.) You may connect the PT-Link II directly to your PC by using a crossover cable (by others) as shown. See **Figure 3** for details.
- 2.) You can also connect both your PC and the PT-Link II to an Ethernet Hub with standard CAT5 cables. See **Figure 4** for details.

Locate a CAT5 cable and plug one end into your computer's Ethernet port (use a crossover cable if connecting directly to the PT-Link II). If connecting directly, plug the other end of the Cable into the Ethernet port on the PT-Link II. If connecting through an Ethernet Hub, plug the other end of the PC cable into the hub, and use a second CAT5 cable to connect the PT-Link II to the hub as well.

Power up the PT-Link II by plugging in the power cable. The PT-Link II may take up to three minutes to power up completely. Once the PT-Link II is powered up, depending on which type of BACnet module you have, you should notice that the green GP105 LED remains on or the RUN LED is blinking continuously on the ProtoCessor Board. See **Figure 25** or **27** for a diagram showing the location of the ProtoCessor RUN or GP105 LED.

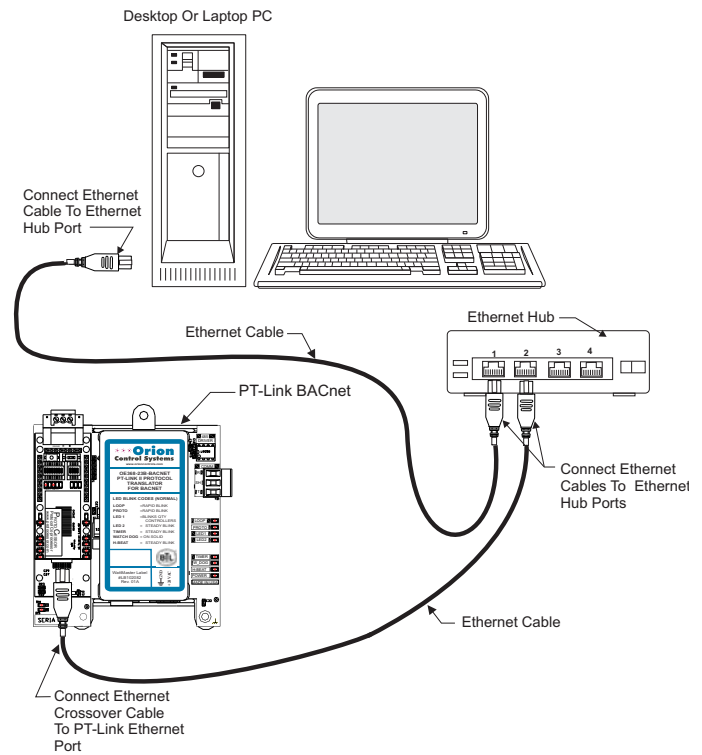
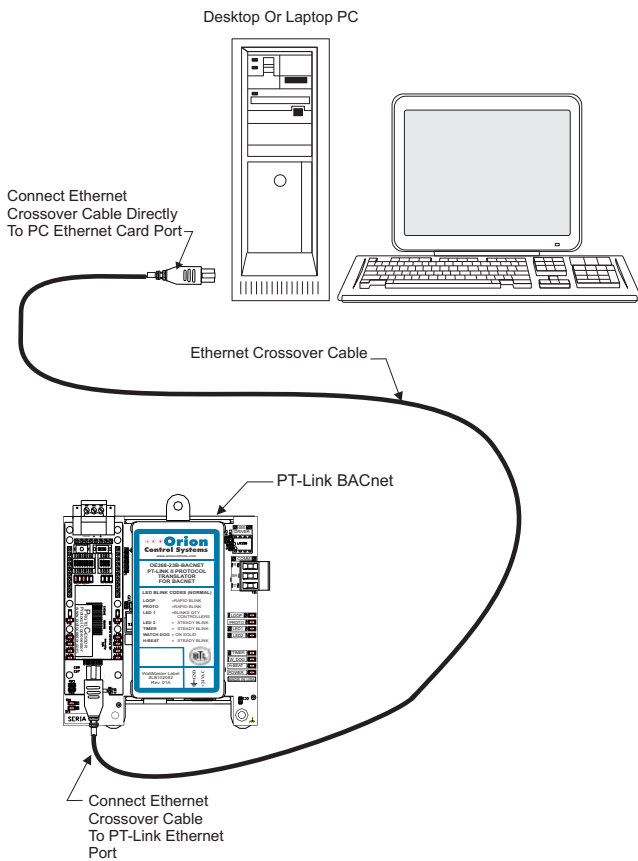

Figure 4: Connecting With Ethernet Cable & Hub

Figure 3: Connecting With Crossover Cable

Computer IP Address Set-up for Windows XP, Vista, and 7

In order for the PT-Link II to communicate properly, it is imperative to set the IP address of both the PT-Link II as well as the computer to be within the same netmask. You need to change the IP address on your computer. The following instructions will explain how to configure the IP address for Microsoft® Windows XP, Vista, and 7 operating systems.

Computer IP Address Set-up for Windows NT & XP

- 1.) Click <start>; then click <Control Panel>.
- 2.) Double-click on the **Network Connections** icon. The *Network Connections Window* will appear (**Figure 5**).

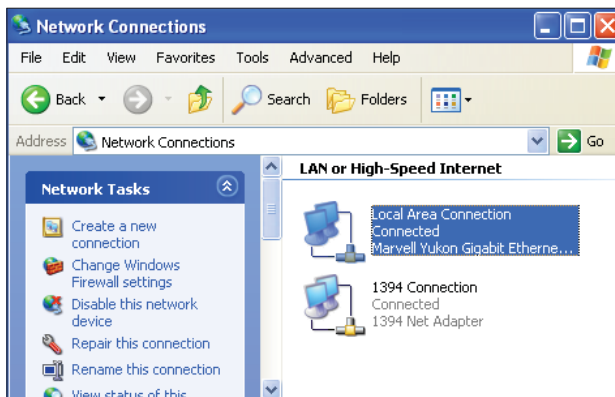

Figure 5: Network Connections Window

NOTE: If any wireless connections are listed, disable them by *right-clicking* the connection and *selecting* <Disable>.

- 3.) In the *Network Connections Window*, double-click the **Local Area Connections** entry. The *Local Area Connection Status Window* will appear (**Figure 6**).

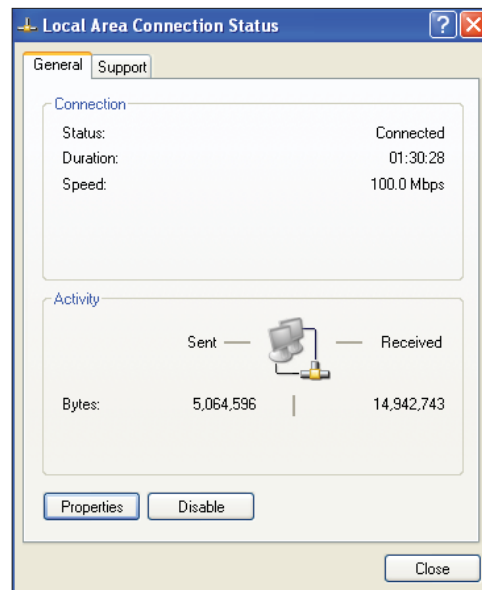

Figure 6: Local Area Connection Status Window

- 4.) As shown in **Figure 6**, click <Properties> in the lower left of the window. The *Local Area Connection Properties Window* will appear.

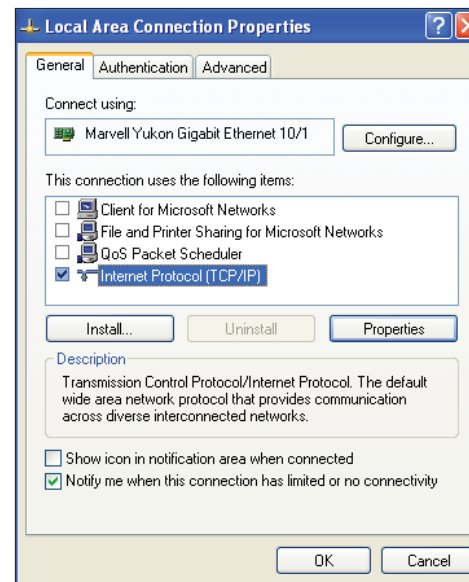

Figure 7: Local Area Connection Properties Window

- 5.) As shown in **Figure 7**, in the Connection Items list box, be sure the **Internet Protocol (TCP/IP)** is checked. *Select the Internet Protocol (TCP/IP) item to highlight it and then click* <Properties>. The *Internet Protocol Properties Window* will appear.

IP Address Configuration

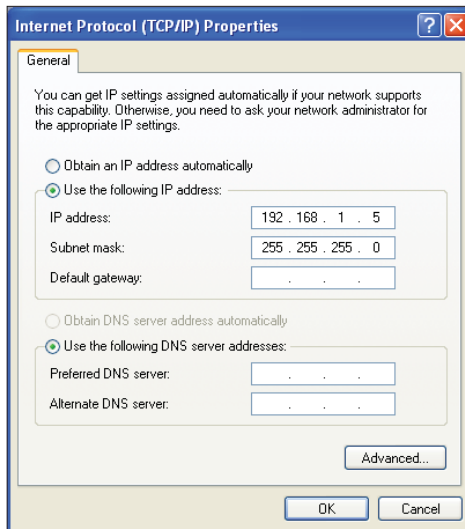

Figure 8: Internet Protocol Properties Window

- 6.) *Select* the radio button in front of **Use the following IP address (Figure 8)** and *write down* the current defaults so that you can re-enter them when you finish configuring the PT-Link and then *type in* the following information:
 - a.) IP address 192.168.1.5
 - b.) Subnet mask 255.255.255.0
 - c.) Default Gateway is blank
 - 7.) *Click* <OK> until all of the above network configuration windows are closed. You may have to *reboot* the computer before the new values are valid.
- 1.) *Click* <start>; then *click* <Control Panel>.
 - 2.) *Click* on the **Network and Internet** icon.
 - 3.) *Click* **Network and Sharing Center**.
 - 4.) From the shaded box in the left side of the window, select **Manage Network Connections** (Vista) or **Change adapter settings** (Windows 7).
 - 5.) *Right-click* on the **Local Area Connection** icon and *select* <Properties> for the drop down window.
 - 6.) *Choose* **Internet Protocol Version 4 (TCP/IPv4)** by highlighting it and then *click* <Properties>. The *Internet Protocol Properties Window* will appear (**Figure 8**).
 - 7.) *Select* the radio button in front of **Use the following IP address (Figure 8)** and write down the current defaults so that you can re-enter them when you finish configuring the PT-Link and then type in the following information:
 - a.) IP address 192.168.1.5
 - b.) Subnet mask 255.255.255.0
 - c.) Default Gateway is blank
 - 9.) *Click* <OK> until all of the above network configuration windows are closed. You may have to *reboot* the computer before the new values are valid.

Computer IP Address Set-up for Windows Vista & 7

Configuring the PT-Link DIP Switches

PT-Link DIP Switch Configuration

If the BACnet address doesn't need to be any higher than 255, then follow these directions to use the DIP Switch settings to configure your PT-Link II. The DIP Switches are shown in **Figure 9**.

The config.csv file's 'Server_DIP' parameter will default to 'Enabled' which will allow the System_Node_ID (BACnet MAC Address) and Node_ID (Device Instance) to be set using the DIP Switches on the module. See **Figure 17** on **page 12**. With this capability, RUNET is not needed for the initial configuration. Set the DIP Switches, power up the PT-Link II, wait 4 minutes, and your PT-Link II BACnet is ready.

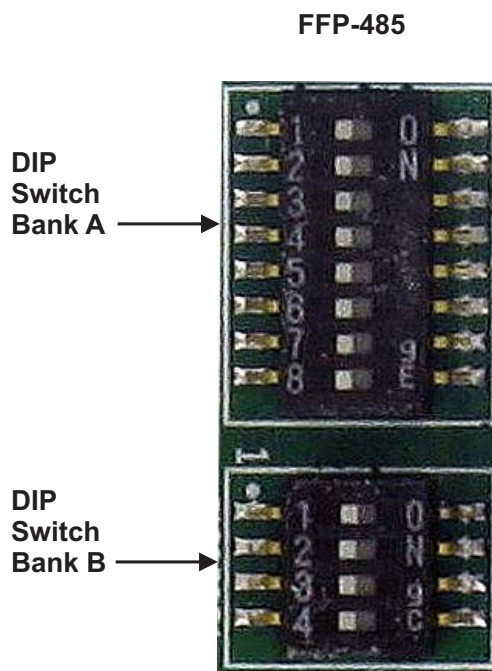

Figure 9: DIP Switches

The DIP Switches allow you to set the Baud Rate, Node-ID (Device Instance), and MAC address on the Field RS-485 protocol as well as to automatically download configuration files for certain protocols.

The DIP Switches are designated by Bank A & B. Bank A is used to select both the MAC Address and Device Instance – if using the DIP switches these will always be the same. The maximum legal value is 255. See **Appendix C** for each possible combination for the addresses.

Bank B is used to set the Server Baud rate. For setting serial field protocol baud rate, the DIP Switches B1 – B4 can be set for the following speeds. See **Table 2** for Server Baud rate settings.

NOTE: You must cycle power after making changes to the DIP Switch Settings for the settings to take effect.

Using B1 – B4 to Set Baud Rate				
Baud	B4	B3	B2	B1
9600	ON	ON	ON	ON
19200	ON	OFF	OFF	OFF
38400	ON	OFF	ON	ON
57600	ON	ON	OFF	OFF
76800	ON	ON	OFF	ON

Table 2: Baud Rate Settings

Running RUINET

Connecting To The PT-Link II

NOTE: The preferred method of configuration is to use the DIP Switches on the Processor board unless your address setting needs to be greater than 255.

1.) In order to communicate and program the PT-Link II you will need to install RUINET software on your computer. If you do not have the software, it is available for downloading at www.orioncontrols.com/software-new.html under PT-Link II Software

WARNING: Make sure to load RUINET onto your hard drive and run the program from your hard drive. DO NOT under any circumstances run RUINET from your cd drive.

2.) If RUINET is in the desktop directory (if it isn't, locate its directory), double-click on RUINET, and the RUINET program should run. Initially, you might see the screen below (**Figure 10**).

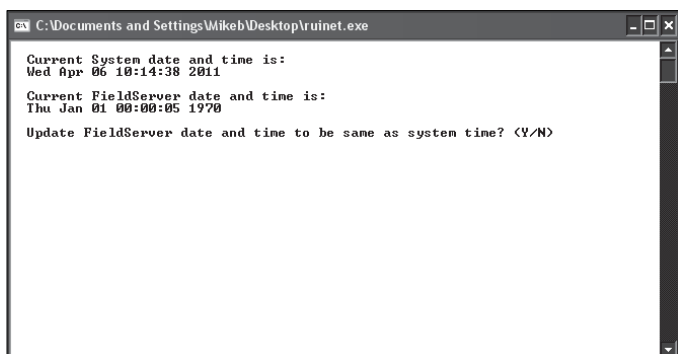

```

C:\Documents and Settings\Mikeb\Desktop\ruiet.exe
Current System date and time is:
Wed Apr 06 10:14:38 2011
Current FieldServer date and time is:
Thu Jan 01 00:00:05 1970
Update FieldServer date and time to be same as system time? <Y/N>

```

Figure 10: Update FieldServer Date and Time

3.) Type <Y> to sync the Date/Time on your PC. The following screen will appear (**Figure 11**). Press any key to continue.

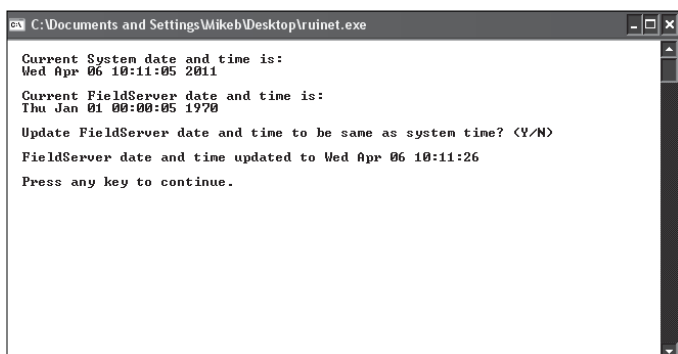

```

C:\Documents and Settings\Mikeb\Desktop\ruiet.exe
Current System date and time is:
Wed Apr 06 10:11:05 2011
Current FieldServer date and time is:
Thu Jan 01 00:00:05 1970
Update FieldServer date and time to be same as system time? <Y/N>
FieldServer date and time updated to Wed Apr 06 10:11:26
Press any key to continue.

```

Figure 11: FieldServer Date and Time Updated

4.) The following screen may appear (**Figure 12**). Type <I> for Specify IP Address and the message “Enter IP Address of the Field Server to Connect to” will appear on the screen.

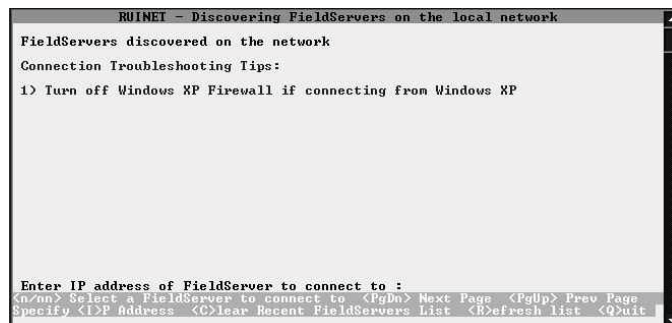

```

RUINET - Discovering FieldServers on the local network
FieldServers discovered on the network
Connection Troubleshooting Tips:
1) Turn off Windows XP Firewall if connecting from Windows XP

Enter IP address of FieldServer to connect to :
<n/nn> Select a FieldServer to connect to <PgDn> Next Page <PgUp> Prev Page
Specify <I>P Address <C>lear Recent FieldServers List <R>efresh list <Q>uit

```

Figure 12: RUINET PT-Link Specify IP Address

5.) Type the IP Address of <192.168.1.24> and press <Enter>.

6.) If you have only one PT-Link connected to the network, then RUINET will automatically connect to that particular PT-Link; otherwise, a menu will appear to allow the selection of the desired PT-Link.

NOTE: If RUINET is unable to establish a connection, there are a few simple procedures you can perform to try to determine the problem. To verify your network cables, observe the green LED displayed directly above and to the right of the Ethernet port. This LED should be on if the 10 BaseT cable is good. Secondly, observe the red LED displayed directly above and to the left of the Ethernet port. This LED should be solid while RUINET is running. If the LEDs are lit as expected, and RUINET still does not receive replies, then the netmask is probably incorrect. If this does not help, then your Ethernet setup on your PC is possibly not compatible. Ensure that you have an Ethernet adapter installed in your software configuration and that it is configured to run the TCP/IP protocol. If you are still unable to connect, please contact WattMaster Controls.

7.) On subsequent connections, a list of PT-Links that have been recently connected may appear under the message “Recently connected to FieldServers”. Select the required PT-Link by *typing* the Number or Letter in the left hand column. (Figure 13).

```

Command Prompt - ruinet

FieldServers discovered on the network
1  Testing Modbus           192.168.0.45
2  Toolkit Pro Server      192.168.0.252

Recently connected to FieldServers
A  No_Title_Assigned      192.168.0.45
B  Toolkit Pro Server      192.168.0.252

<n/nn> Select a FieldServer to connect to <PgDn> Next Page <PgUp> Prev Page
Specify <I>P Address <C>lear Recent FieldServers List <R>efresh list <Q>uit
  
```

Figure 13: RUINET PT-Link Selection Menu

8.) Once connected, you will see the *RUINET Main Menu* (Figure 14). Unless you need to make changes to the config.csv file (steps 7 through 15), you are now ready to send and receive files to and from the PT-Link.

```

Command Prompt - ruinet

Toolkit Pro Server
B - FieldServer Information

O - Connection Overview
N - Mode Overview
M - Map Descriptor Overview
A - Data Array Overview

E - System Errors
F - Driver Messages

D - Download Configuration to FieldServer
U - Upload Configuration from FieldServer

I - Change IP Address
K - Change UI Display Mode
! - Restart FieldServer

Keys: Type Appropriate Key for Selection
<Q>uit <+> Next <-> Prev <Ctrl+> Last <Ctrl+> First <n> Goto
  
```

Figure 14: RUINET PT-Link II Main Menu

9.) *Type* the letter <U> to upload the Config file (Figure 15), then *type* <U> again (Figure 16) for Upload.

```

Command Prompt - ruinet

Toolkit Pro Server
B - FieldServer Information

O - Connection Overview
N - Mode Overview
M - Map Descriptor Overview
A - Data Array Overview

E - System Errors
F - Driver Messages

D - Download Configuration to FieldServer
U - Upload Configuration from FieldServer

I - Change IP Address
K - Change UI Display Mode
! - Restart FieldServer

Keys: Type Appropriate Key for Selection
<Q>uit <+> Next <-> Prev <Ctrl+> Last <Ctrl+> First <n> Goto
  
```

Figure 15: RUINET PT-Link Main Menu - Upload

```

Command Prompt - ruinet

R - Remote ( FieldServer ) Filename      config.csv
L - Local ( PC ) Filename                 config.csv
U - Upload

Keys: Type Appropriate Key for Selection
Enable <O>ther Files Up and Download <ESC>
  
```

Figure 16: RUINET PT-Link Upload

10.) You will get confirmation that the upload is complete. *Type* <N> to open the file in Notepad.

WARNING: Only edit the config.csv file using Notepad. **DO NOT** use Excel. Using Excel to edit the config.csv file will corrupt its contents!

Changing the Config.csv File

11.) Inside the text file under ‘Connections’, you must change the ‘Server_DIP’ parameter from ‘Enabled’ to ‘Disabled’ and then you can use RUINET to configure the addresses and baud rate. (See **Figure 17**).

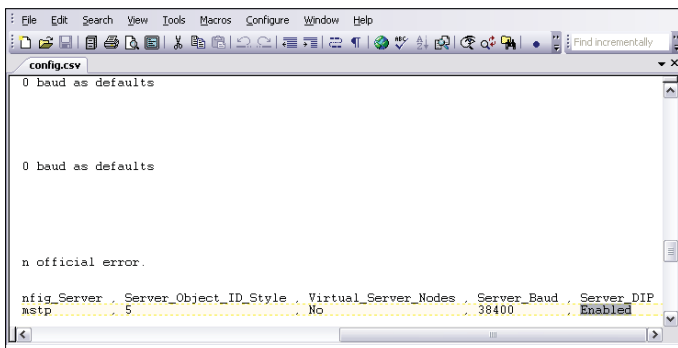

Figure 17: Changing the ‘Server_DIP’ parameter

12.) Inside the text file you can change the System_Node_ID (the BACnet MAC address) which defaults to 11 (**Figure 18**). You can obtain this information from your Building Automation System (BAS) Integrator.

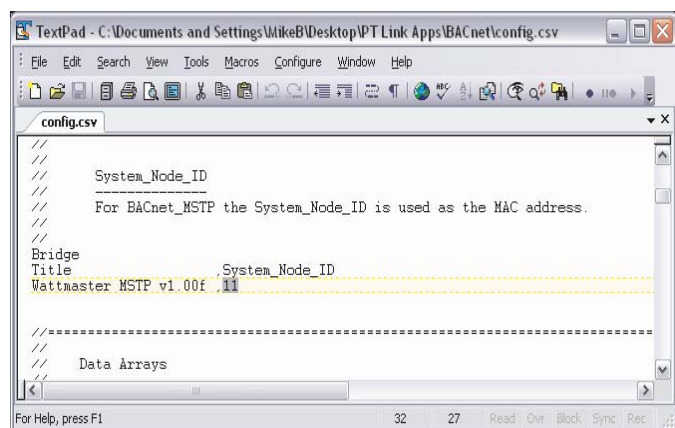

Figure 18: Changing the BACnet MAC address

13.) If the server baud rate needs to be changed, go to the ‘Connections’ section and only change the SERVER_BAUD (**Figure 19**). Possible Baud Rate values are (9600, 19200, 38400, 76800). The default Baud Rate is 38400. You can obtain this information from your BAS Integrator.

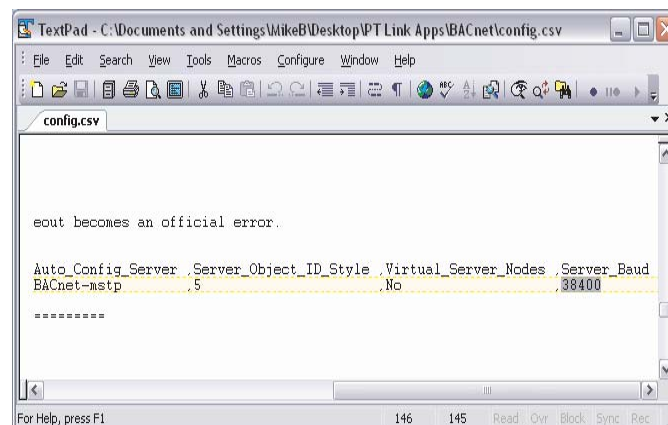

Figure 19: Changing the Baud Rate in Notepad

14.) The last change you may need to make is the Node_ID under ‘Client Side Nodes’ which is the BACnet Device Instance Number (**Figure 20**). The default is 1. You can obtain this information from your BAS Integrator.

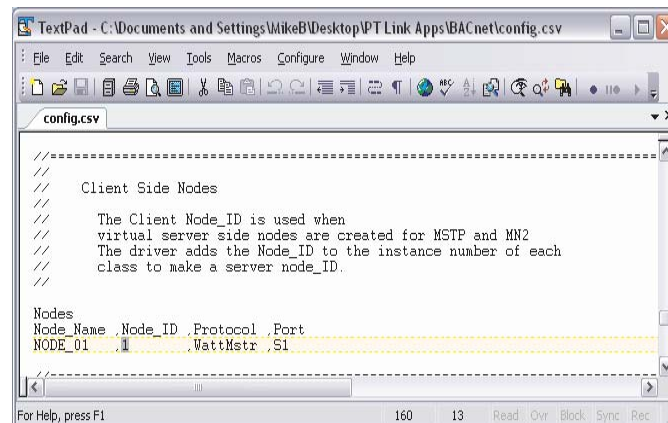

Figure 20: Changing the Node ID in Notepad

Verifying PT-Link Communications

15.) Once the changes are made to the text file, *click* <File> in the upper left and then *click* <Save>. Now close the file and return to the *RUINET Main Menu*.

16.) From the *RUINET Main Menu*, type <D> to Download the new config.csv file to the FieldServer (**Figure 21**).

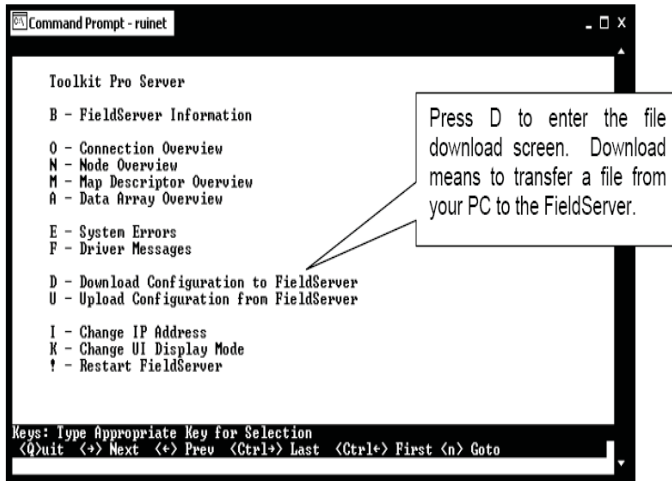

Figure 21: Download new Config.csv file

17.) At the next screen, (**Figure 22**), type <D> again.

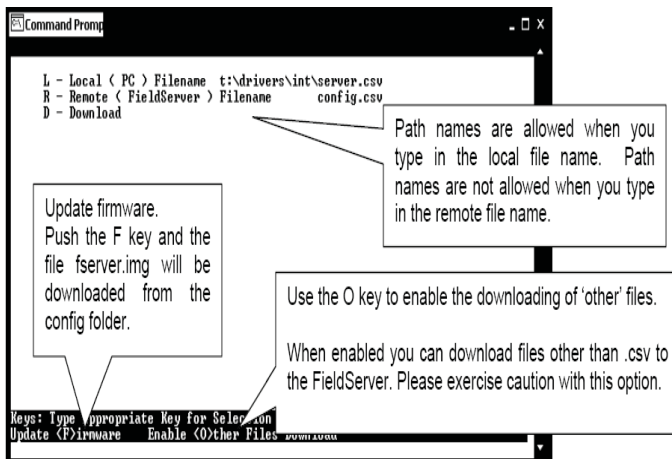

Figure 22: Download new Config.csv file

NOTE: The utility will indicate when downloading is complete. **DO NOT** reset the PT-Link until this message is displayed, as this will corrupt the PT-Link.

NOTE: The Remote Filename option must always be named “**config.csv**” for configurations; otherwise, it will be ignored by the PT-Link.

18.) Once the download is complete, *restart* the PT-Link II by cycling power or *press* <ESC> to get back to the *RUINET Main Menu* and then *type* <!> option to save the new configuration file and restart RUINET. It is possible to do multiple downloads to the PT-Link II before resetting it. There will be a start-up period where you will be unable to connect to the PT Link.

19.) From the *RUINET Main Menu*, type <A> for the Data Array Overview. The *Data Array Overview Screen* will display (**Figure 23**).

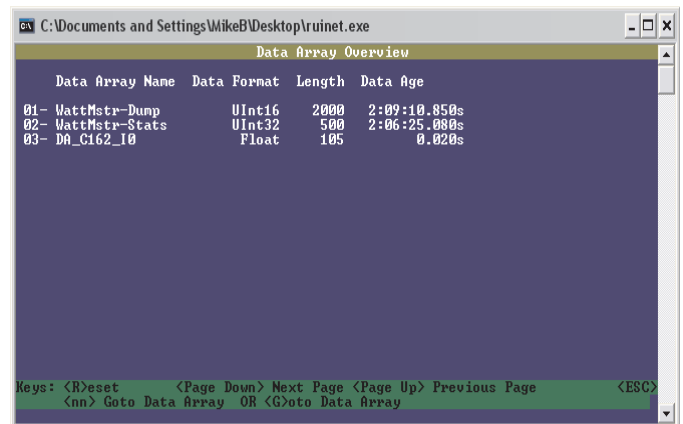

Figure 23: Data Array Overview Screen

20.) This screen (**Figure 23**) will verify communication to the HVAC units. Lines 1 & 2 should always be present. After a start-up period of approximately 4 minutes, you will see 1 additional line for each HVAC unit. This screen represents the PT Link II communicating with 1 HVAC unit.

21.) Once these steps have been completed and you have verified that the reconfigured PT Link II has established communication to the HVAC unit(s), it can now be added to the BAS network.

Troubleshooting the PT-Link Controller

Addressing WattMaster Devices in a BACnet® Network.

Each PT-Link II BACnet® generates only one BACnet® device regardless of the number of WattMaster controls connected to it. This device will have all the properties of all the WattMaster controls connected. The instance of the device is equal to the unit address. The properties of each control can be differentiated by an offset of 500.

Examples:

- 1.) Properties of the controller address as 1 will range from 0 to 499.
- 2.) Properties of the controller address as 2 will range from 500 to 999.
- 3.) Properties of the controller address as 3 will range from 1000 to 1499.

To search for the instance of a specific property, follow the next formula:

Property Instance = ((Controller Address - 1) * 500) + Instance Number from table.

Example:

- 1.) The PT-Link II BACnet® has a Node ID equal to five.
- 2.) Two VCM controllers connected and addressed to one and four.
- 3.) Searching for the Outdoor Temperature of each controller.
- 4.) Instance of the Outdoor Temperature in the VCM table equal to AI: 54.
- 5.) Client will only see Device 5.
- 6.) Under Device 5 it will see AI: 54 for the Outdoor Temperature of the unit addressed as 1 and AI: 1554 for the Outdoor Temperature of the unit addressed as 4.

NOTE: To simplify the calculation, we recommend that the WattMaster controllers be addressed in sequential order from one to the last controller without any unused address(es) in between.

Troubleshooting the PT-Link II Controller

PT-Link II Board LEDs

The PT-Link II BACnet® is equipped with LEDs that can be used for troubleshooting. There are eight LEDs on the PT-Link board. See **Figure 24** for the locations of the LEDs on the PT-Link board. The LED descriptions and functions are listed in the following paragraphs.

POWER LED

When the PT-Link II BACnet® is powered up, the **“POWER”** LED should light up and stay on continuously. If it does not light up, check to be sure that you have 24 VAC connected to the board, that the wiring connections are tight, and that they are wired for correct polarity. The 24 VAC power must be connected so that all ground wires remain common. If after making all these checks the **“POWER”** LED still does not light up, please contact WattMaster Controls Technical Support at our Toll Free number—866-918-1100—for assistance.

LOOP LED

When power is applied to the PT-Link II BACnet®, the **“LOOP”** LED will also light up. The LED should flicker rapidly, indicating that the PT-Link is trying to communicate with the controllers on the loop. A **“flicker”** is defined as a brief moment when the LED turns off and back on. If the **“LOOP”** LED does not operate as indicated above, first power down the unit and then reapply power. If this does not work, please contact WattMaster Controls Technical Support at our Toll Free number—866-918-1100—for assistance.

LED 1

When power is first applied, **“LED 1”** will be off temporarily and then will blink one time for each controller it is communicating with. For example, if you have 4 controllers on the loop connected to the PT-Link, **“LED 1”** will blink 4 times. If the amount of blinks does not match the number of controllers connected to the loop, it indicates there is a communications problem. The best way to find out which board is not communicating is to go to each controller and look at its **“COMM”** LED. The **“COMM”** LED should be solid and will flicker occasionally indicating communication with the PT-Link II BACnet®. If the **“COMM”** LED does not flicker, there is no communication with that controller.

LED 2

When power is first applied, **“LED 2”** will be off temporarily and then will blink slowly indicating that the PT-Link baseboard is communicating with the ProtoCessor Module. If **“LED 2”** does not blink, check that the ProtoCessor Module is installed correctly on the PT-Link baseboard and that the **“PWR”** LED is lit up on the ProtoCessor Module.

PROTO LED

When the PT-Link II is first powered up, the **“PROTO”** LED should light up and blink continuously. This LED verifies communication with the board and the ProtoCessor. If the LED doesn't light up, check that the ProtoCessor is installed correctly and firmly connected to the Base Board. The **“PWR”** LED should also be lit on the ProtoCessor Module.

TIMER LED

The **“TIMER”** LED is used for troubleshooting by WattMaster Controls Technical Support. The **“TIMER”** LED should always be blinking steadily.

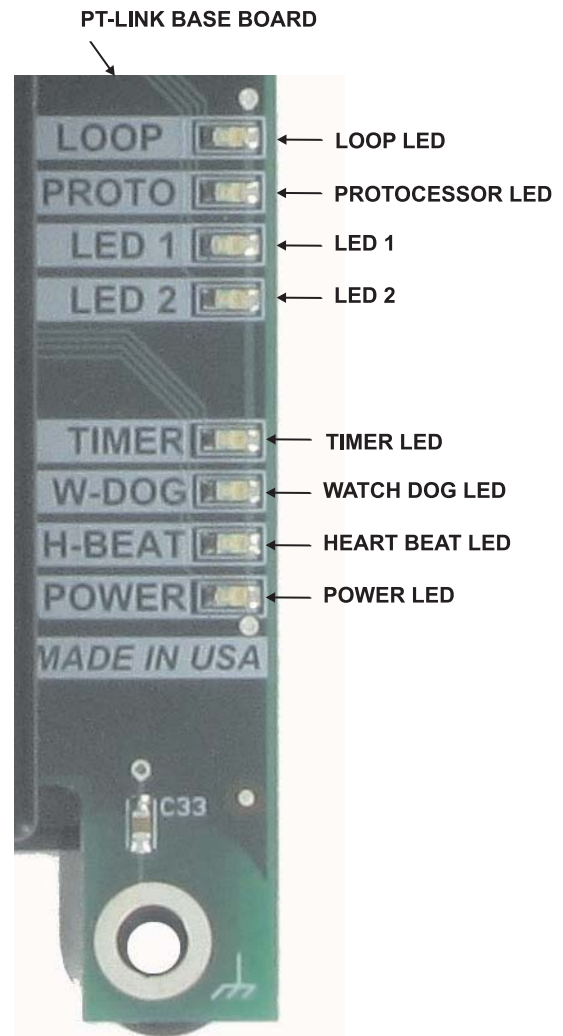

Figure 24: PT-Link II BACNET® LED Locations

WATCH DOG LED

The **“W-DOG”** LED is used for troubleshooting by WattMaster Controls Technical Support. The **“W-DOG”** LED should always be on solid.

HEARTBEAT LED

The **“H-BEAT”** LED blinks to show the PT-Link II board software is running. If the LED doesn't light up, and all other checks have been made, please contact WattMaster Controls Technical Support at our Toll Free number—866-918-1100—for assistance.

Troubleshooting the PT-Link II Controller - OE368-23B-BACnet

ProtoCessor Module LEDs

Refer to **Figure 25** for LED locations. NOTE: If your BACnet module does not have DIP switches, refer to **Figure 27** on **page 17**.

PWR LED

When the PT-Link II is first powered up, the “**PWR**” green LED should light up and stay on continuously. If the LED doesn’t light up, check that the ProtoCessor is installed correctly and firmly connected to the Base Board.

UNUSED LEDs

15 seconds after powering up, the 4 unused LEDs will turn on solid for 5 seconds, then turn off.

RX & TX LEDs

During normal operation, the “**RX**” LED will flash when a message is received on the field port of the ProtoCessor and the “**TX**” LED will flash when a message is sent on the field port of the ProtoCessor. The “**TX**” and “**RX**” LEDs work together to indicate that communication is being established with the desired protocol network. If both LEDs are blinking, then communication is working properly. If not, check the protocol network wiring and the baud rate in the configuration file.

RUN LED

The “**RUN**” LED will flash 20 seconds after power up, signifying normal operation. The ProtoCessor will be able to access RUIINET once this LED starts flashing. During the first 20 seconds, the LED should be off.

SYS ERR LED

The “**SYS ERR**” LED will go on solid 15 seconds after power up. It will turn off after 5 seconds. A steady red light will indicate there is a system error on the ProtoCessor. If this occurs, immediately report the related “system error” shown in the error screen of the Remote User Interface to FieldServer Technologies for evaluation.

COMM ERR

The “**COMM ERR**” LED will go on solid 15 seconds after power up. It will turn off after 5 seconds. A steady red light will indicate a communications problem if there is a configured node connected to the ProtoCessor that is offline. To establish the cause of the error, go to the error screen of the Remote User Interface interface.

CONFIG ERR LED

The “**CONFIG ERR**” LED will go on solid 15 seconds after power up. It will turn off after 5 seconds. A steady amber light will indicate a configuration error exists in the active configuration. See the Error Screen in the Remote User Interface for a description of the configuration error.

NODE OFFLINE LED

The “**NODE OFFLINE**” LED will go on solid 15 seconds after power up. It will turn off after 5 seconds. If the Node Offline LED stays on solid, a node offline condition has occurred.

NOTE: If all of these tests are made and the controller still doesn’t operate, please contact WattMaster Controls Technical Support at our Toll Free number—866-918-1100—for assistance.

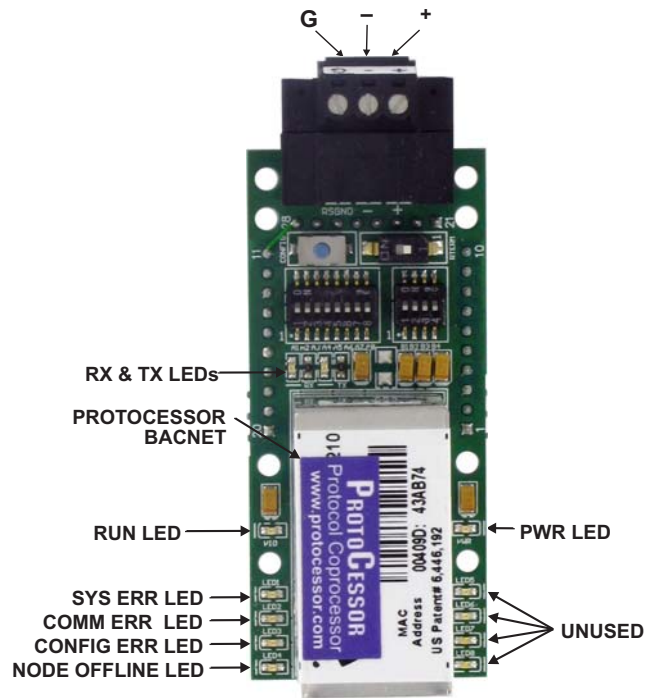

Figure 25: PT-Link II BACNET® LED Locations

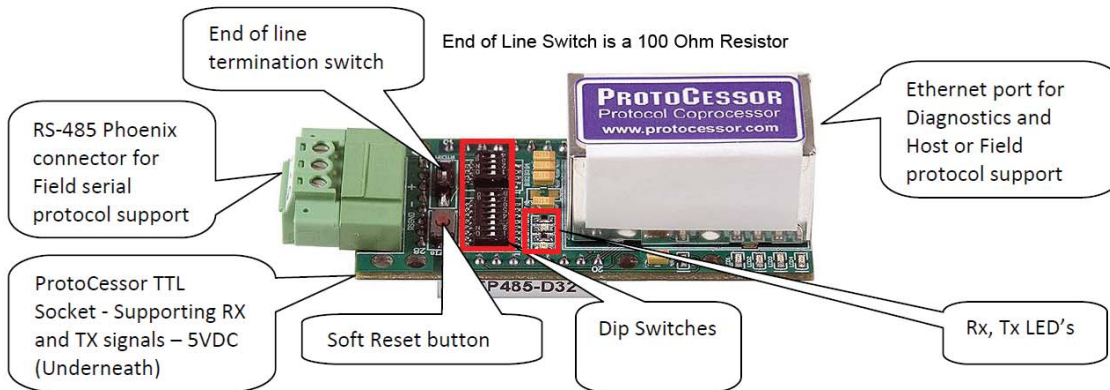

Figure 26: PT-Link II BACNET® ProtoCessor Components

Troubleshooting the PT-Link II Controller - OE368-23-BACnet

ProtoCessor Module LEDs

Refer to **Figure 27** for LED locations. NOTE: If your BACnet module has DIP switches, refer to **Figure 25** on page 16.

PWR LED

When the PT-Link II is first powered up, the “**PWR**” LED should light up and stay on continuously. If the LED doesn’t light up, check that the ProtoCessor is installed correctly and firmly connected to the Base Board.

GPI05 LED

The “**GPI05**” LED will light up when the Base Board and the ProtoCessor Module have established communications. This can take up to 3 minutes depending on the number of units connected to the PT-Link II. If it fails to light up after 3 minutes, check that the ProtoCessor is installed correctly and firmly to the Base Board.

LB LED

Once the unit is powered up, the “**LB**” LED must be blinking constantly. If this LED is constantly on or off, the Module is not working properly and needs to be replaced.

LA LED

Once the unit is powered up, the “**LA**” LED must be blinking constantly. If this LED is constantly on or off, the Module is not working properly and needs to be replaced.

TX & RX LEDs

The “**TX**” and “**RX**” LEDs work together to indicate that communication is being established with the desired protocol network. If both LEDs are blinking, then communication is working properly. If not, check the protocol network wiring and the baud rate in the configuration file.

D14 & D15 LEDs

The “**D14**” and “**D15**” LEDs work together to indicate that communication is being transmitted and received from the USB Port when performing an update to the PT-Link software.

NOTE: If all of these tests are made and the controller still doesn’t operate, please contact WattMaster Controls Technical Support at our Toll Free number—866-918-1100—for assistance.

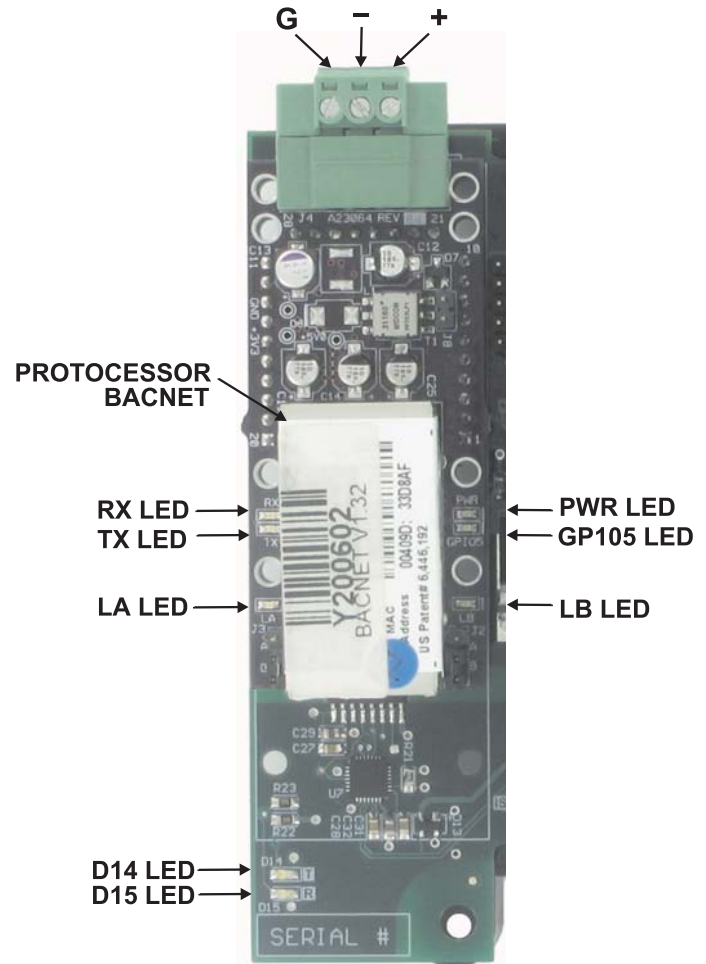

Figure 27: PT-Link II BACNET® LED Locations

Troubleshooting the PT-Link II Controller

Using RUINET

Before continuing with the troubleshooting, make sure the PT-Link is connected correctly and the RUINET software is installed, running, and functioning correctly.

Verifying Proper Communications

From the *RUINET Main Screen*, press <O> to go the *Connection Overview Screen*. This screen supplies information on communication between the PT-Link and remote devices. A number of aspect screens are available, and some of the aspect screens have more than one page. Use the space bar to toggle between aspects and use the <PgUp> and <PgDn> keys to toggle between pages of the same aspect. The *Connection Overview and Settings Aspect Screen* is shown in **Figure 28**.

The main purpose in this screen is to verify that messages and characters are being transmitted and received. In addition, it shows the number of communication errors. If the PT-Link connection “03” is the protocol connection, verify that is communicating appropriately. If it is not, check that the PT-Link LEDs are working properly, the unit is wired correctly, and the PT-Link is configured correctly (Baud Rate, Unit Address & MAC Address). If the number of errors is constantly increasing, move to the *Error Screen* by pressing the <Space Bar> 3 times to find out the cause of the errors. Use the <PgUp> and <PgDn> keys to toggle between pages of the *Error Screen*.

Verifying Proper Values

To verify that the correct values for each unit are being communicated to the PT-Link, move to the *Data Array Overview Screen*. To get to the screen, press <A> from the *RUINET Main Menu*. See **Figure 29** for screen details.

In the *Data Array Overview Screen* (**Figure 29**) you will be able to see the data arrays of all the units connected to the PT-Link denoted by an array name “DA_XXX_IY”—Y being the address of the unit minus one. The Address of the unit is determined by a set of DIP switches. To view the values being communicated from a specific unit, move to the *Data Array Detail Screen* (**Figure 30**) of the unit by entering the number under which it is listed. For example, for the unit listed in the third position, enter <O3>.

To understand what each value means, look at the Data Array Tables for the desired unit type, VCM-X, SA, or VCM. You can change the writable values from this screen by using the modify command. To use the modify command, press <M> from the *Data Array Detail Screen* and then enter the Offset you want to change followed by a space and the new value.

Example: To change the Cooling Supply Setpoint to 60 in the VCM, press <M>, enter <58 60>, and then press <Enter>. This could be useful to prove that the unit can take and keep the setpoints properly.

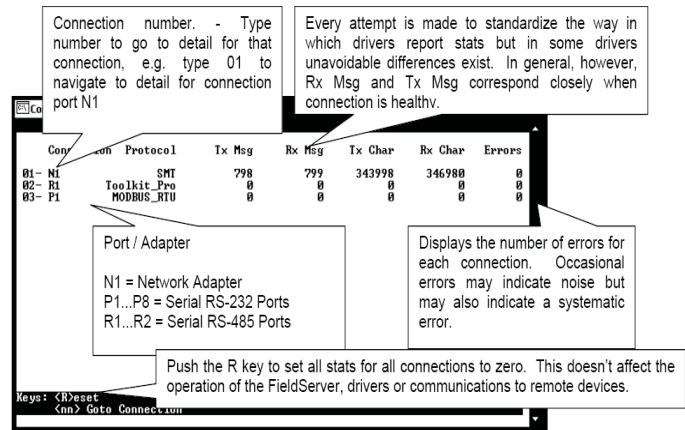

Figure 28: Connection Overview Screen

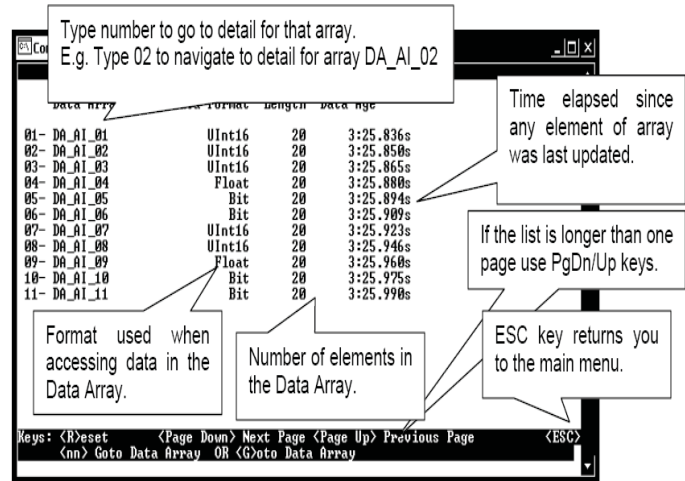

Figure 29: Data Array Overview Screen

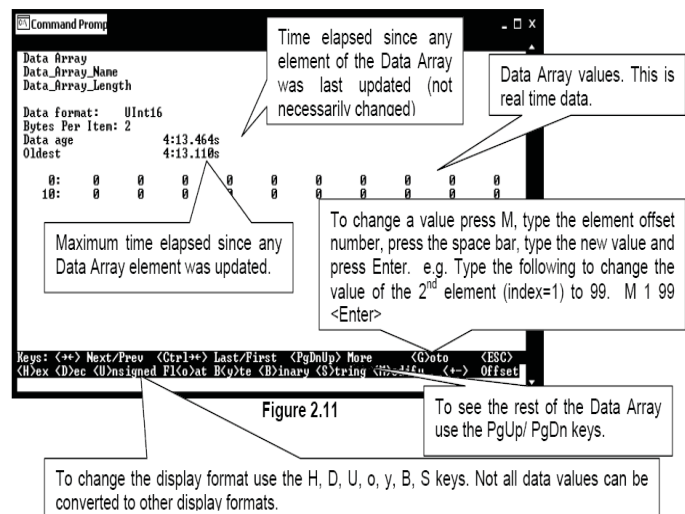

Figure 30: Data Array Detail Screen

Updating the PT-Link II Controller

Programming the PT-Link II with BootLoader

The PT-Link II is equipped with the ability to update its software with the use of a computer. You will need the following before you begin:

- PT-Link II in need of an update (powered up, no other connections necessary)
- Computer running Microsoft Windows™ operating system
- Prism II software from www.orioncontrols.com/software-new.html
- Latest version of PT-Link II software (e-mailed from our tech support staff or downloaded from any of our websites) and software sheet
- USB Driver Setup.exe file from PT-Link II CD or downloaded from any of our websites.
- USB cable

Follow these simple steps to update the PT-Link II:

1.) Turn on your computer and download the latest Prism II software from www.orioncontrols.com/software-new.html.

2.) Either download the PT-Link II update file from <http://techsupport.wattmaster.com> or save the file to your computer from the e-mail you received from Tech Support. Record the path and name of the file for later use. Also, print the software sheet provided for future reference.

3.) Run the USB Driver Setup.exe file (found on the PT-Link II CD or downloaded from any of our websites) so that Prism can communicate to the PT Link II. Unzip the file to the directory where you saved your PT-Link II software.

4.) Plug the USB cable into the computer's and PT-Link II's USB ports.

5.) A message will pop-up from the lower menu bar of Windows that reads, "Found New Hardware." Click on this message and follow the instructions that appear to install the USB drivers.

6.) Open Prism II and Login with the password "Flash." If successful, "Level 4 Access" will appear at the lower right of the Prism program.

7.) Click on the <Job-Site> icon. The *Job-Sites Window* will appear. In the *Type of CommLink Dialog Box*, select "Hi Speed CommLink."



8.) In the *Job-Sites Window*, from the Serial Port drop down list, select the correct COM port. If you don't know the COM port number or if the number is 10 or higher, follow the directions on pages 19-20.

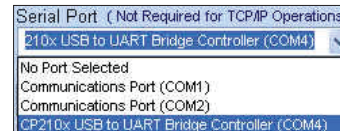

9.) From Prism II's Communications tab, select "Flash Selected Controller."



10.) The *Flash Controller Window* will appear.

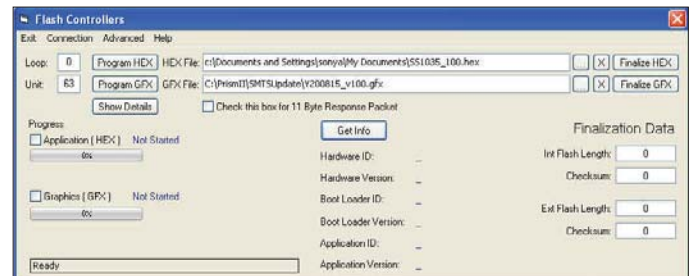

11.) From the *Flash Controller Window's* Connection tab, select "Direct". Keep the *Flash Controller Window* open.



12.) Cycle power to the PT-Link II and within 5 seconds, click the <Get Info> button in the *Flash Controller Window*. The PT-Link II information will now appear in the window under the <Get Info> button.



Updating the PT-Link II Controller

13.) The Application ID should be SS1035 and the Application Version should match the software version you will be updating to.

14.) In the HEX File field, enter the path and name of the HEX file you downloaded and/or copied to your hard drive. Use the Browse button (...) to the right of the field if you need help in locating the file.

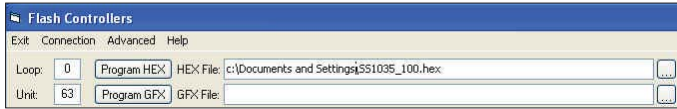

15.) Now, cycle power to the PT-Link II once again and within 5 seconds click on the <Program HEX> button (shown above). If successful, you should see the Progress Application HEX bar showing the progress percentage.

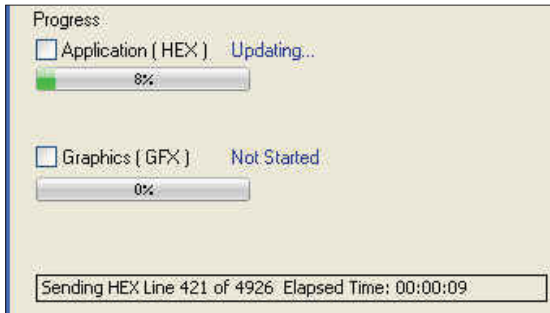

16.) When the bar shows 100% completed, verify the PT-Link II's software is running by observing the Timer LED blinking.

17.) Verify the PT-Link II's Application Version by once again cycling power to the PT-Link II and within 5 seconds clicking the <Get Info> button.

18.) Verify all fields are correct in the information below the <Get Info> button and under "Finalization Data." The "Int Flash Length" and "Checksum" values should match the values provided with the software sheet.

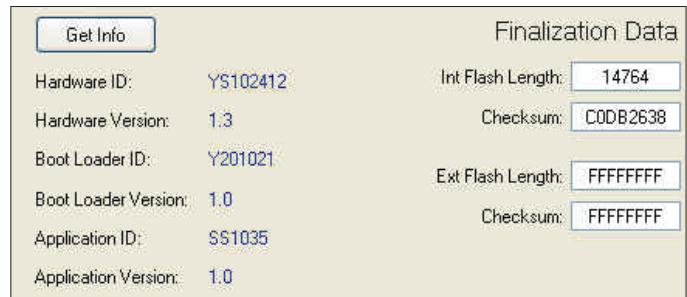

Updating the PT-Link II Controller

Finding What COM Port Number the CommLink IV is Using

1. *Left-click* on <Start>, located on the bottom left of the Windows Tool Bar.



2. *Select* <Control Panel>.

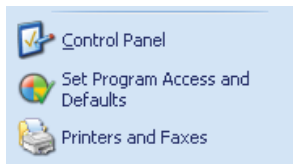

3. *Double-click* the System Icon.



System

4. *Click* the <Hardware> tab.

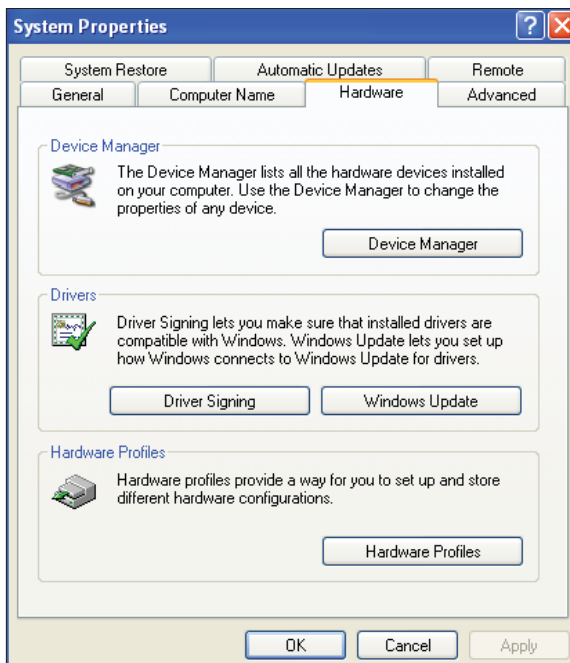

5. *Click* the <Device Manager> button.

6. *Click* on the plus sign next to Ports to see all of the common ports.

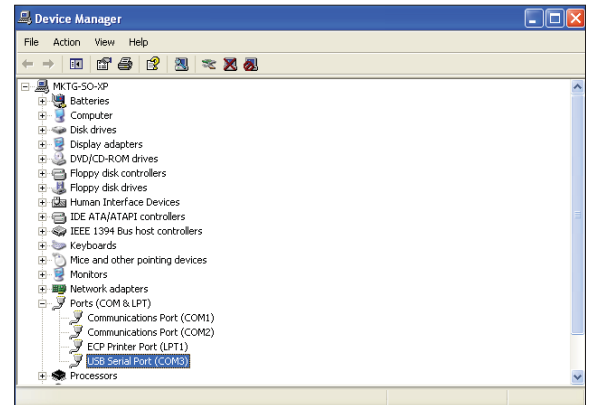

7. *Locate* the USB Serial Port (COM#). The COM# in parentheses is the port it is located on. *Write* this COM port number down. You will need to know this when setting up the Prism software.
8. If the COM port number is 10 or greater, go to “Changing the USB COM Port Number” on page 20.

Updating the PT-Link II Controller

Changing the USB COM Port Number

When the CommLink is first plugged in, it will be assigned a COM port number to be used for communicating with the Prism software. If the port number is 10 or greater, it needs to be changed to a value less than 10 to be recognized by Prism.

1. Click <Start>, click <Control Panel>, click <System>, click the <Hardware> tab, and then click <Device Manager> to get to the *Device Manager Window*.
2. Click on the plus sign next to Ports to see all of the COM ports.

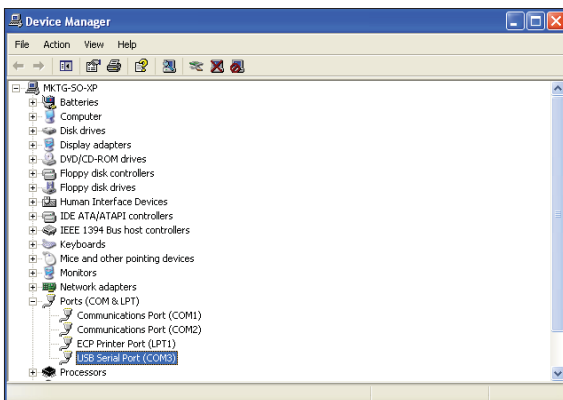

3. Right-click on “USB Serial Port (COM#)” and select <Properties>. In the *Properties Window*, select the <Port Settings> tab.

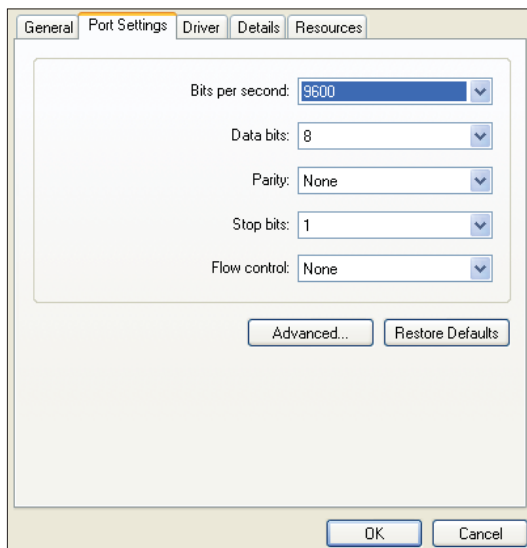

4. To assign a port number less than 10, click on <Advanced>. The *Advanced Settings Window* will appear.

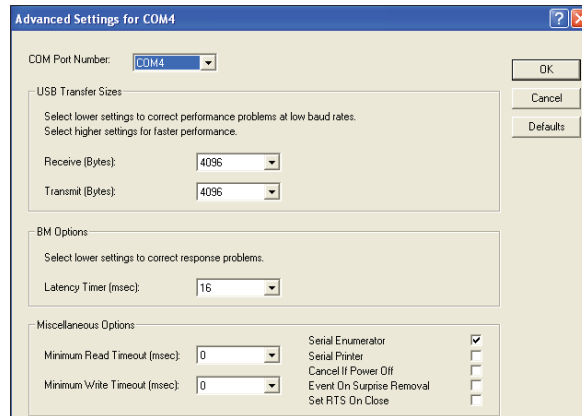

5. In the COM Port Number drop box, select which COM port you wish to use. Make sure you select a COM port number that is not currently in use (you can see the ports in use in the *Device Manager Window*). Select a port that is less than 10.

NOTE: Windows® will assign a port number to every device that has ever been installed on your computer. So if there are no available ports below 10, choose a port number less than 10 for a device listed that you know you are not currently using.

6. Once you select the correct COM port number, click <OK> and close any windows opened in the process of changing the port number. Make note of this number because you will need it for your Prism setup.

VCB-X & VCM-X Modular Data Arrays

VCB-X Modular Data Array For Field Server								
Offset	0	1	2	3	4	5	6	7
0	AppVer	ClSt	HtSt	SpCtp	SaTp	OaTp	UnitMode	CtrlSts
8	ClEnbl	HtEnbl	EcoEnbl	FanDly	OnRlys	EcoPos	VfdBwPos	AlmSts
16	AlmGrp1	AlmGrp2	AlmGrp3	CtrlTp	InRh	InRhStM	MdClPos	MdHtPos
24	OcpClSt	OcpHtSt	UnClOst	UnHtOst	SaClSt	SaHtSt	SpCtpOst	SaTpOst
32	OaTpOst	SchdFrc	OnRly1	OnRly2	OnRly3	OnRly4	OnRly5	OnRly6
40	MnExRly1	MnExRly2	MnExRly3	MnExRly4	MnExRly5	RIExRly1	RIExRly2	RIExRly3
48	RIExRly4	RIExRly5	RIExRly6	RIExRly7	RIExRly8	RIExRly9	RIExRly10	RIExRly11
56	RIExRly12	MinEcoSt	OaCFM	EtCFM	SaCFM	FrcHvacM	FrcFanSp	FrcEcono
64	SaTpStM	RaTp	OaRh	StaticPr	CO2	BuildPr	EtFnSpd	CoilTp
72	RaCFM	HeadPr	RtVlvPos	LvWtrTp	MdGsVPos	HeadPrSt	CdCtrSg1	OaClSt
80	OaHtSt	WmupTg	RhDewpSt	EcoEnbSt	RaTpOst	ColTpOft	LWAmbnt	PreHtAmb
88	CO2MinLv	CO2MaxLv	InRhSt	StatPrSt	RfPrSt	OACfmMin	HiInRh	ClHdPrSt
96	HtHdPrSt	LoClTpSt	HiClTpSt	–	–	–	–	–

Table 3: VCB-X Modular Data Array For Field Server

VCM-X Modular Data Array For Field Server								
Offset	0	1	2	3	4	5	6	7
0	AppVer	ClSt	HtSt	OaWtbl	TpDmnd	SpCtp	SaTp	RaTp
8	OaTp	DuctPr	OaRh	UnitMode	CtrlSts	ClEnbl	HtEnbl	EcoEnbl
16	FanDly	PofCfg	CO2Cfg	MdHt2Ins	Rt2Ins	OnRlys	ExRlys12	ExRlys34
24	EcoPos	VfdBwPos	VfdExPos	AlmSts	AlmGrp1	AlmGrp2	AlmGrp3	SaTpAlm
32	OaTpAlm	SpCtpAlm	MchClAlm	MchHtAlm	PofAlm	DrtFAlm	SmokeAlm	LoSaAlm
40	HiSaAlm	CtrlTpCF	CtrlTpHF	CtrlTp	InRh	InRhStM	DptStM	MdClPos
48	MdHtPos	MdHt2Pos	Rt2Pos	OcpClSt	OcpHtSt	UnClOst	UnHtOst	WtblSt
56	SaClSt	SaHtSt	WmupSt	SpCtpOst	SaTpOst	RaTpOst	OaTpOst	CoilTpSt
64	DptSt	InRhSt	DuctPrSt	RfPrSt	SchdFrc	OnRly1	OnRly2	OnRly3
72	OnRly4	OnRly5	ExRly1	ExRly2	ExRly3	ExRly4	ExRly5	ExRly6
80	ExRly7	ExRly8	ExRly9	ExRly10	ExRly11	ExRly12	ExRly13	ExRly14
88	ExRly15	ExRly16	CO2St	MinEcoSt	CO2Level	ByPasDmp	RaDmp	RfPr
96	OaDwpt	CoilTp	SaTpStM	PreHtSp	OaCFM	EtCFM	SaCFM	OACfmSt
104	OACfmRs	OACfmStM	MdCmp2	HdPr1	HdPr2	CdFan1	CdFan2	RmVFDPos

Table 4: VCM-X Modular Data Array For Field Server

VCM-X WSHP Tulsa & Coil Data Arrays

VCM-X WSHP (Tulsa) Data Array For Field Server								
Offset	0	1	2	3	4	5	6	7
0	AppVer	ClSt	HtSt	OaWtbl	TpDmnd	SpCtp	SaTp	RaTp
8	OaTp	DuctPr	OaRh	UnitMode	CtrlSts	ClEnbl	HtEnbl	EcoEnbl
16	FanDly	PofCfg	CO2Cfg	MdHt2Ins	Rt2Ins	OnRlys	ExRlys12	ExRlys34
24	EcoPos	VfdBwPos	VfdExPos	AlmSts	AlmGrp1	AlmGrp2	AlmGrp3	SaTpAlm
32	OaTpAlm	SpCtpAlm	MchClAlm	MchHtAlm	PofAlm	DrtFAlm	SmokeAlm	LoSaAlm
40	HiSaAlm	CtrlTpCF	CtrlTpHF	CtrlTp	InRh	InRhStM	DptStM	MdClPos
48	MdHtPos	MdHt2Pos	Rt2Pos	OcpClSt	OcpHtSt	UnClOst	UnHtOst	WtblSt
56	SaClSt	SaHtSt	WmupSt	SpCtpOst	SaTpOst	RaTpOst	OaTpOst	CoilTpSt
64	DptSt	InRhSt	DuctPrSt	RfPrSt	SchdFrc	OnRly1	OnRly2	OnRly3
72	OnRly4	OnRly5	ExRly1	ExRly2	ExRly3	ExRly4	ExRly5	ExRly6
80	ExRly7	ExRly8	ExRly9	ExRly10	ExRly11	ExRly12	ExRly13	ExRly14
88	ExRly15	ExRly16	CO2St	MinEcoSt	CO2Level	ByPasDmp	RaDmp	RfPr
96	OaDwpt	CoilTp	SaTpStM	PreHtSp	OaCFM	EtCFM	SaCFM	OACfmSt
104	OACfmRs	OACfmStM	MdCmp2	HdPr1	HdPr2	CdFan1	CdFan2	WaterTpA
112	WaterTpB	A1LSPAlm	A1LktAlm	A2LSPAlm	A2LktAlm	B1LSPAlm	B1LktAlm	B2LSPAlm
120	B2LktAlm	LWT1Alm	LWT2Alm	POWF1Alm	POWF2Alm	ComMAlm	RmVFDPos	-

Table 5: VCM-X WSHP (Tulsa) Data Array For Field Server

VCM-X WSHP (Coil) Data Array For Field Server								
Offset	0	1	2	3	4	5	6	7
0	AppVer	ClSt	HtSt	OaWtbl	TpDmnd	SpCtp	SaTp	RaTp
8	OaTp	DuctPr	OaRh	UnitMode	CtrlSts	ClEnbl	HtEnbl	EcoEnbl
16	FanDly	PofCfg	CO2Cfg	MdHt2Ins	Rt2Ins	OnRlys	ExRlys12	ExRlys34
24	EcoPos	VfdBwPos	VfdExPos	AlmSts	AlmGrp1	AlmGrp2	AlmGrp3	SaTpAlm
32	OaTpAlm	SpCtpAlm	MchClAlm	MchHtAlm	PofAlm	DrtFAlm	SmokeAlm	LoSaAlm
40	HiSaAlm	CtrlTpCF	CtrlTpHF	CtrlTp	InRh	InRhStM	DptStM	MdClPos
48	MdHtPos	MdHt2Pos	Rt2Pos	OcpClSt	OcpHtSt	UnClOst	UnHtOst	WtblSt
56	SaClSt	SaHtSt	WmupSt	SpCtpOst	SaTpOst	RaTpOst	OaTpOst	CoilTpSt
64	DptSt	InRhSt	DuctPrSt	RfPrSt	SchdFrc	OnRly1	OnRly2	OnRly3
72	OnRly4	OnRly5	ExRly1	ExRly2	ExRly3	ExRly4	ExRly5	ExRly6
80	ExRly7	ExRly8	ExRly9	ExRly10	ExRly11	ExRly12	ExRly13	ExRly14
88	ExRly15	ExRly16	CO2St	MinEcoSt	CO2Level	ByPasDmp	RaDmp	RfPr
96	OaDwpt	CoilTp	SaTpStM	PreHtSp	OaCFM	EtCFM	SaCFM	OACfmSt
104	OACfmRs	OACfmStM	MdCmp2	HdPr1	HdPr2	CdFan1	CdFan2	WaterTpA
112	A1LSPAlm	A1LktAlm	B1LSPAlm	B1LktAlm	LWT1Alm	POWF1Alm	ComMAlm	RmVFDPos

Table 6: VCM-X WSHP (Coil) Data Array For Field Server

VCM-X Data Array For Field Server								
Offset	0	1	2	3	4	5	6	7
0	AppVer	ClSt	HtSt	OaWtbl	TpDmnd	SpCtp	SaTp	RaTp
8	OaTp	DuctPr	OaRh	UnitMode	CtrlSts	ClEnbl	HtEnbl	EcoEnbl
16	FanDly	PofCfg	CO2Cfg	MdHt2Ins	Rt2Ins	OnRlys	ExRlys12	ExRlys34
24	EcoPos	VfdBwPos	VfdExPos	AlmSts	AlmGrp1	AlmGrp2	AlmGrp3	SaTpAlm
32	OaTpAlm	SpCtpAlm	MchClAlm	MchHtAlm	PofAlm	DrtFAlm	SmokeAlm	LoSaAlm
40	HiSaAlm	CtrlTpCF	CtrlTpHF	CtrlTp	InRh	InRhStM	DptStM	MdClPos
48	MdHtPos	MdHt2Pos	Rt2Pos	OcpClSt	OcpHtSt	UnClOst	UnHtOst	WtblSt
56	SaClSt	SaHtSt	WmupSt	SpCtpOst	SaTpOst	RaTpOst	OaTpOst	CoilTpSt
64	DptSt	InRhSt	DuctPrSt	RfPrSt	SchdFrc	OnRly1	OnRly2	OnRly3
72	OnRly4	OnRly5	ExRly1	ExRly2	ExRly3	ExRly4	ExRly5	ExRly6
80	ExRly7	ExRly8	ExRly9	ExRly10	ExRly11	ExRly12	ExRly13	ExRly14
88	ExRly15	ExRly16	CO2St	MinEcoSt	CO2Level	ByPasDmp	RaDmp	RfPr
96	OaDwpt	CoilTp	SaTpStM	PreHtSp	OaCFM	EtCFM	SaCFM	OACfmSt
104	OACfmRs	OACfmStM	–	–	–	–	–	–

Table 7: VCM-X Data Array For Field Server

SA Controller Data Array For Field Server								
Offset	0	1	2	3	4	5	6	7
0	AppVer	ClSt	HtSt	TpDmnd	SpCtp	SaTp	DuctPr	UnitMode
8	CtrlSts	ClEnbl	HtEnbl	EcoEnbl	FanDly	MdHt2Ins	Rt2Ins	EcoPos
16	VfdBwPos	SaTpAlm	SpCtpAlm	MchClAlm	MchHtAlm	PofAlm	DrtFAlm	LoSaAlm
24	HiSaAlm	CtrlTpCF	CtrlTpHF	CtrlTp	InRh	InRhStM	DptStM	MdClPos
32	MdHtPos	MdHt2Pos	Rt2Pos	OcpClSt	OcpHtSt	UnClOst	UnHtOst	SaClSt
40	SaHtSt	WmupSt	SpCtpOst	SaTpOst	CoilTpSt	DptSt	InRhSt	DuctPrSt
48	SchdFrc	OnRly1	OnRly2	OnRly3	OnRly4	OnRly5	ExRly1	ExRly2
56	ExRly3	ExRly4	ExRly5	ExRly6	ExRly7	ExRly8	ExRly9	ExRly10
64	ExRly11	ExRly12	ExRly13	ExRly14	ExRly15	ExRly16	CoilTp	SaTpStM
72	PreHtSp	EaTp	EwTp	EaRH	HdPr1	HdPr2	CoilTp2	EaDpt
80	WSEByp	WSEByp2	MdCmp2	CoilTpSt	CdPos1	CdPos2	EaTpAlm	EmerAlm
88	PoWFAlm	DrmAlm	EaTpOst	EwTpOst	–	–	–	–

Table 8: SA Controller Data Array For Field Server

VCM Data Array

VCM Data Array For Field Server								
Offset	0	1	2	3	4	5	6	7
0	AppVer	ClSt	HtSt	OaWtbl	TpDmnd	SpCtp	SaTp	RaTp
8	OaTp	DuctPr	OaRh	UnitMode	CtrlSts	ClDmnd	HtDmnd	DehmDmnd
16	ClEnbl	HtEnbl	EcoEnbl	FanDly	WmupDmnd	PofCfg	CO2Cfg	MdHt2Ins
24	Rt2Ins	OnRlys	ExRlys12	ExRlys34	EcoPos	VfdBwPos	VfdExPos	AlmSts
32	AlmGrp1	AlmGrp2	AlmGrp3	SaTpAlm	OaTpAlm	SpCtpAlm	MchClAlm	MchHtAlm
40	PofAlm	DrtFlAlm	SmokeAlm	LoSaAlm	HiSaAlm	CtrlTpCF	CtrlTpHF	CtrlTp
48	InRh	InRhStM	DptStM	MdClPos	MdHtPos	MdHt2Pos	Rt2Pos	OcpClSt
56	OcpHtSt	UnClOst	UnHtOst	WtblSt	SaClSt	SaHtSt	WmupSt	SpCtpOst
64	SaTpOst	RaTpOst	OaTpOst	CoilTpSt	DptSt	InRhSt	DuctPrSt	RfPrSt
72	SchdFrc	OnRly1	OnRly2	OnRly3	OnRly4	OnRly5	ExRly1	ExRly2
80	ExRly3	ExRly4	ExRly5	ExRly6	ExRly7	ExRly8	ExRly9	ExRly10
88	ExRly11	ExRly12	ExRly13	ExRly14	ExRly15	ExRly16	CO2St	MinEcoSt
96	CO2Level	ByPasDmp	RaDmp	RfPr	OaDwpt	CoilTp	SaTpStM	PreHtSp

Table 9: VCM Data Array For Field Server

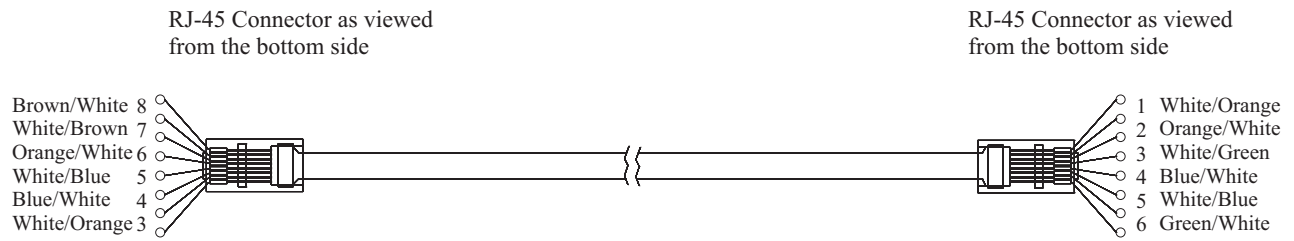

Use the standard EIA/TIA color code for "CROSS OVER CABLE" as shown.
It is not the same as a standard Cat 5 patch cabling. The outer cable jacket should be "Orange" in color. This is not a straight thru pin 1 to pin 1 cable.

Figure 31: RJ-45 8P8C Cable for WattMaster Cross Over Networking - WattMaster Part #HZ000136

Appendix B

ProtoCessor Driver - (PICS) BACnet Protocol Implementation Conformance Statement

BACnet® Protocol

Date:	April 2010
Vendor Name:	FieldServer Technologies
Product Name:	FieldServer ProtoCessor FPC-FD2
Product Model Number:	ProtoCessor FPC-FD2
Product Description:	ProtoCessors are low cost TTL to RS-485 and Ethernet Embedded Coprocessor modules enabling OEM's to rapidly implement BACnet in their products. Any third-party vendor can use ProtoCessor modules to add a BACnet interface to their devices.
Protocol Conversions:	See FieldServer Technologies list of protocol drivers available to determine available protocol conversions.

BACnet Standardized Device Profile (Annex L)

- BACnet Application Specific Controller (B-ASC)

BACnet Interoperability Building Blocks Supported (Annex K):

- K.1.2 BIBB - Data Sharing - ReadProperty-B (DS-RP-B)
- K.1.4 BIBB - Data Sharing - ReadPropertyMultiple-B (DS-RPM-B)
- K.1.8 BIBB - Data Sharing - WriteProperty-B (DS-WP-B)
- K.1.10 BIBB - Data Sharing - WritePropertyMultiple-B (DS-WPM-B)
- K.1.12 BIBB - Data Sharing - COV-B (DS-COV-B)
- K.2.2 BIBB - Alarm and Event-Notification Internal-B (AE-N-I-B)
- K.2.5 BIBB - Alarm and Event-ACK-B (AE-ACK-B)
- K.2.11 BIBB - Alarm and Event-Information-B (AE-INFO-B)
- K.5.1 BIBB - Device Management - Dynamic Device Binding-A (DM-DDB-A)
- K.5.2 BIBB - Device Management - Dynamic Device Binding-B (DM-DDB-B)
- K.5.4 BIBB - Device Management - Dynamic Object Binding-B (DM-DOB-B)
- K.5.6 BIBB - Device Management - Device Communication Control-B (DM-DCC-B)
- K.5.12 BIBB - Device Management - Time Synchronization-B (DM-TS-B)
- K.5.22 BIBB - Device Management - List Manipulation-B (DM-LM-B)

Segmentation Capability: None

Standard Object Types Supported

- Device Object
- Analog Input
- Analog Output
- Analog Value
- Binary Input
- Binary Output
- Binary Value
- Multi State Input
- Multi State Output
- Multi State Value
- Notification Class Object

For all of these properties, the following applies:

- 1.) Does not support BACnet CreateObject
- 2.) Does not support BACnet DeleteObject
- 3.) No proprietary properties exist

Data Link Layer Options:

- BACnet IP, (Annex J)
- MS/TP master (Clause 9), baud rate up to 76.8 Kbps
- MS/TP slave (Clause 9), baud rate up to 76.8 Kbps

Device Address Binding: Not supported

Networking Options:

- Router, Clause 6 – List all routing configurations, e.g., ARCNET-Ethernet, Ethernet-MS/TP, etc.
- Annex H, BACnet Tunneling Router over IP
- BACnet/IP Broadcast Management Device (BBMD)
- Registrations by Foreign Devices

Character Sets Supported:

Where support for multiple character sets is indicated, this does not imply that they can all be supported simultaneously.

- ANSI X3.4
- ISO 10646 (UCS-2)
- IBM/Microsoft DBCS
- ISO 10646 (ICS-4)
- ISO 8859-1
- JIS C

Appendix C - Node ID (Device Instance) & MAC Address

Bank A DIP Switch Settings								
A8	A7	A6	A5	A4	A3	A2	A1	Address
Off	Off	Off	Off	Off	Off	Off	Off	0
Off	Off	Off	Off	Off	Off	Off	On	1
Off	Off	Off	Off	Off	Off	On	Off	2
Off	Off	Off	Off	Off	Off	On	On	3
Off	Off	Off	Off	Off	On	Off	Off	4
Off	Off	Off	Off	Off	On	Off	On	5
Off	Off	Off	Off	Off	On	On	Off	6
Off	Off	Off	Off	Off	On	On	On	7
Off	Off	Off	Off	On	Off	Off	Off	8
Off	Off	Off	Off	On	Off	Off	On	9
Off	Off	Off	Off	On	Off	On	Off	10
Off	Off	Off	Off	On	Off	On	On	11
Off	Off	Off	Off	On	On	Off	Off	12
Off	Off	Off	Off	On	On	Off	On	13
Off	Off	Off	Off	On	On	On	Off	14
Off	Off	Off	Off	On	On	On	On	15
Off	Off	Off	On	Off	Off	Off	Off	16
Off	Off	Off	On	Off	Off	Off	On	17
Off	Off	Off	On	Off	Off	On	Off	18
Off	Off	Off	On	Off	Off	On	On	19
Off	Off	Off	On	Off	On	Off	Off	20
Off	Off	Off	On	Off	On	Off	On	21
Off	Off	Off	On	Off	On	On	Off	22
Off	Off	Off	On	Off	On	On	On	23
Off	Off	Off	On	On	Off	Off	Off	24
Off	Off	Off	On	On	Off	Off	On	25
Off	Off	Off	On	On	Off	On	Off	26
Off	Off	Off	On	On	Off	On	On	27
Off	Off	Off	On	On	On	Off	Off	28
Off	Off	Off	On	On	On	Off	On	29
Off	Off	Off	On	On	On	On	Off	30
Off	Off	Off	On	On	On	On	On	31
Off	Off	On	Off	Off	Off	Off	Off	32
Off	Off	On	Off	Off	Off	Off	On	33
Off	Off	On	Off	Off	Off	On	Off	34
Off	Off	On	Off	Off	Off	On	On	35
Off	Off	On	Off	Off	On	Off	Off	36
Off	Off	On	Off	Off	On	Off	On	37
Off	Off	On	Off	Off	On	On	Off	38
Off	Off	On	Off	Off	On	On	On	39
Off	Off	On	Off	On	Off	Off	Off	40
Off	Off	On	Off	On	Off	Off	On	41
Off	Off	On	Off	On	Off	On	Off	42
Off	Off	On	Off	On	Off	On	On	43
Off	Off	On	Off	On	On	Off	Off	44
Off	Off	On	Off	On	On	Off	On	45

Bank A DIP Switch Settings								
A8	A7	A6	A5	A4	A3	A2	A1	Address
Off	Off	On	Off	On	On	On	Off	46
Off	Off	On	Off	On	On	On	On	47
Off	Off	On	On	Off	Off	Off	Off	48
Off	Off	On	On	Off	Off	Off	On	49
Off	Off	On	On	Off	Off	On	Off	50
Off	Off	On	On	Off	Off	On	On	51
Off	Off	On	On	Off	On	Off	Off	52
Off	Off	On	On	Off	On	Off	On	53
Off	Off	On	On	Off	On	On	Off	54
Off	Off	On	On	Off	On	On	On	55
Off	Off	On	On	On	Off	Off	Off	56
Off	Off	On	On	On	Off	Off	On	57
Off	Off	On	On	On	Off	On	Off	58
Off	Off	On	On	On	Off	On	On	59
Off	Off	On	On	On	On	Off	Off	60
Off	Off	On	On	On	On	Off	On	61
Off	Off	On	On	On	On	On	Off	62
Off	Off	On	On	On	On	On	On	63
Off	On	Off	Off	Off	Off	Off	Off	64
Off	On	Off	Off	Off	Off	Off	On	65
Off	On	Off	Off	Off	Off	On	Off	66
Off	On	Off	Off	Off	Off	On	On	67
Off	On	Off	Off	Off	On	Off	Off	68
Off	On	Off	Off	Off	On	Off	On	69
Off	On	Off	Off	Off	On	On	Off	70
Off	On	Off	Off	Off	On	On	On	71
Off	On	Off	Off	On	Off	Off	Off	72
Off	On	Off	Off	On	Off	Off	On	73
Off	On	Off	Off	On	Off	On	Off	74
Off	On	Off	Off	On	Off	On	On	75
Off	On	Off	Off	On	On	Off	Off	76
Off	On	Off	Off	On	On	Off	On	77
Off	On	Off	Off	On	On	On	Off	78
Off	On	Off	Off	On	On	On	On	79
Off	On	Off	On	Off	Off	Off	Off	80
Off	On	Off	On	Off	Off	Off	On	81
Off	On	Off	On	Off	Off	On	Off	82
Off	On	Off	On	Off	Off	On	On	83
Off	On	Off	On	Off	On	Off	Off	84
Off	On	Off	On	Off	On	Off	On	85
Off	On	Off	On	Off	On	On	Off	86
Off	On	Off	On	Off	On	On	On	87
Off	On	Off	On	On	Off	Off	Off	88
Off	On	Off	On	On	Off	Off	On	89
Off	On	Off	On	On	Off	On	Off	90
Off	On	Off	On	On	Off	On	On	91

Appendix C - Node ID (Device Instance) & MAC Address

Bank A DIP Switch Settings								
A8	A7	A6	A5	A4	A3	A2	A1	Address
Off	On	Off	On	On	On	Off	Off	92
Off	On	Off	On	On	On	Off	On	93
Off	On	Off	On	On	On	On	Off	94
Off	On	Off	On	On	On	On	On	95
Off	On	On	Off	Off	Off	Off	Off	96
Off	On	On	Off	Off	Off	Off	On	97
Off	On	On	Off	Off	Off	On	Off	98
Off	On	On	Off	Off	Off	On	On	99
Off	On	On	Off	Off	On	Off	Off	100
Off	On	On	Off	Off	On	Off	On	101
Off	On	On	Off	Off	On	On	Off	102
Off	On	On	Off	Off	On	On	On	103
Off	On	On	Off	On	Off	Off	Off	104
Off	On	On	Off	On	Off	Off	On	105
Off	On	On	Off	On	Off	On	Off	106
Off	On	On	Off	On	Off	On	On	107
Off	On	On	Off	On	On	Off	Off	108
Off	On	On	Off	On	On	Off	On	109
Off	On	On	Off	On	On	On	Off	110
Off	On	On	Off	On	On	On	On	111
Off	On	On	On	Off	Off	Off	Off	112
Off	On	On	On	Off	Off	Off	On	113
Off	On	On	On	Off	Off	On	Off	114
Off	On	On	On	Off	Off	On	On	115
Off	On	On	On	Off	On	Off	Off	116
Off	On	On	On	Off	On	Off	On	117
Off	On	On	On	Off	On	On	Off	118
Off	On	On	On	Off	On	On	On	119
Off	On	On	On	On	Off	Off	Off	120
Off	On	On	On	On	Off	Off	On	121
Off	On	On	On	On	Off	On	Off	122
Off	On	On	On	On	Off	On	On	123
Off	On	On	On	On	On	Off	Off	124
Off	On	On	On	On	On	Off	On	125
Off	On	On	On	On	On	On	Off	126
Off	On	On	On	On	On	On	On	127
On	Off	Off	Off	Off	Off	Off	Off	128
On	Off	Off	Off	Off	Off	Off	On	129
On	Off	Off	Off	Off	Off	On	Off	130
On	Off	Off	Off	Off	Off	On	On	131
On	Off	Off	Off	Off	On	Off	Off	132
On	Off	Off	Off	Off	On	Off	On	133
On	Off	Off	Off	Off	On	On	Off	134
On	Off	Off	Off	Off	On	On	On	135
On	Off	Off	Off	On	Off	Off	Off	136
On	Off	Off	Off	On	Off	Off	On	137

Bank A DIP Switch Settings								
A8	A7	A6	A5	A4	A3	A2	A1	Address
On	Off	Off	Off	On	Off	On	Off	138
On	Off	Off	Off	On	Off	On	On	139
On	Off	Off	Off	On	On	Off	Off	140
On	Off	Off	Off	On	On	On	Off	141
On	Off	Off	Off	On	On	On	On	142
On	Off	Off	Off	On	On	On	On	143
On	Off	Off	On	Off	Off	Off	Off	144
On	Off	Off	On	Off	Off	Off	On	145
On	Off	Off	On	Off	Off	On	Off	146
On	Off	Off	On	Off	Off	On	On	147
On	Off	Off	On	Off	On	Off	Off	148
On	Off	Off	On	Off	On	Off	On	149
On	Off	Off	On	Off	On	On	Off	150
On	Off	Off	On	Off	On	On	On	151
On	Off	Off	On	On	Off	Off	Off	152
On	Off	Off	On	On	Off	Off	On	153
On	Off	Off	On	On	Off	On	Off	154
On	Off	Off	On	On	Off	On	On	155
On	Off	Off	On	On	On	Off	Off	156
On	Off	Off	On	On	On	Off	On	157
On	Off	Off	On	On	On	On	Off	158
On	Off	Off	On	On	On	On	On	159
On	Off	On	Off	Off	Off	Off	Off	160
On	Off	On	Off	Off	Off	Off	On	161
On	Off	On	Off	Off	Off	On	Off	162
On	Off	On	Off	Off	Off	On	On	163
On	Off	On	Off	Off	On	Off	Off	164
On	Off	On	Off	Off	On	Off	On	165
On	Off	On	Off	Off	On	On	Off	166
On	Off	On	Off	Off	On	On	On	167
On	Off	On	Off	On	Off	Off	Off	168
On	Off	On	Off	On	Off	Off	On	169
On	Off	On	Off	On	Off	On	Off	170
On	Off	On	Off	On	Off	On	On	171
On	Off	On	Off	On	On	Off	Off	172
On	Off	On	Off	On	On	Off	On	173
On	Off	On	Off	On	On	On	Off	174
On	Off	On	Off	On	On	On	On	175
On	Off	On	On	Off	Off	Off	Off	176
On	Off	On	On	Off	Off	Off	On	177
On	Off	On	On	Off	Off	On	Off	178
On	Off	On	On	Off	Off	On	On	179
On	Off	On	On	Off	On	Off	Off	180
On	Off	On	On	Off	On	Off	On	181
On	Off	On	On	Off	On	On	Off	182
On	Off	On	On	Off	On	On	On	183

Appendix C - Node ID (Device Instance) & MAC Address

Bank A DIP Switch Settings								
A8	A7	A6	A5	A4	A3	A2	A1	Address
On	Off	On	On	On	Off	Off	Off	184
On	Off	On	On	On	Off	Off	On	185
On	Off	On	On	On	Off	On	Off	186
On	Off	On	On	On	Off	On	On	187
On	Off	On	On	On	On	Off	Off	188
On	Off	On	On	On	On	Off	On	189
On	Off	On	On	On	On	On	Off	190
On	Off	On	On	On	On	On	On	191
On	On	Off	Off	Off	Off	Off	Off	192
On	On	Off	Off	Off	Off	Off	On	193
On	On	Off	Off	Off	Off	On	Off	194
On	On	Off	Off	Off	Off	On	On	195
On	On	Off	Off	Off	On	Off	Off	196
On	On	Off	Off	Off	On	Off	On	197
On	On	Off	Off	Off	On	On	Off	198
On	On	Off	Off	Off	On	On	On	199
On	On	Off	Off	On	Off	Off	Off	200
On	On	Off	Off	On	Off	Off	On	201
On	On	Off	Off	On	Off	On	Off	202
On	On	Off	Off	On	Off	On	On	203
On	On	Off	Off	On	On	Off	Off	204
On	On	Off	Off	On	On	Off	On	205
On	On	Off	Off	On	On	On	Off	206
On	On	Off	Off	On	On	On	On	207
On	On	Off	On	Off	Off	Off	Off	208
On	On	Off	On	Off	Off	Off	On	209
On	On	Off	On	Off	Off	On	Off	210
On	On	Off	On	Off	Off	On	On	211
On	On	Off	On	Off	On	Off	Off	212
On	On	Off	On	Off	On	Off	On	213
On	On	Off	On	Off	On	On	Off	214
On	On	Off	On	Off	On	On	On	215
On	On	Off	On	On	Off	Off	Off	216
On	On	Off	On	On	Off	Off	On	217
On	On	Off	On	On	Off	On	Off	218
On	On	Off	On	On	Off	On	On	219
On	On	Off	On	On	On	Off	Off	220
On	On	Off	On	On	On	Off	On	221
On	On	Off	On	On	On	On	Off	222
On	On	Off	On	On	On	On	On	223
On	On	On	Off	Off	Off	Off	Off	224
On	On	On	Off	Off	Off	Off	On	225
On	On	On	Off	Off	Off	On	Off	226
On	On	On	Off	Off	Off	On	On	227
On	On	On	Off	Off	On	Off	Off	228
On	On	On	Off	Off	On	Off	On	229

Bank A DIP Switch Settings								
A8	A7	A6	A5	A4	A3	A2	A1	Address
On	On	On	Off	Off	On	On	Off	230
On	On	On	Off	Off	On	On	On	231
On	On	On	Off	On	Off	Off	Off	232
On	On	On	Off	On	Off	Off	On	233
On	On	On	Off	On	Off	On	Off	234
On	On	On	Off	On	Off	On	On	235
On	On	On	Off	On	On	Off	Off	236
On	On	On	Off	On	On	Off	On	237
On	On	On	Off	On	On	On	Off	238
On	On	On	Off	On	On	On	On	239
On	On	On	On	Off	Off	Off	Off	240
On	On	On	On	Off	Off	Off	On	241
On	On	On	On	Off	Off	On	Off	242
On	On	On	On	Off	Off	On	On	243
On	On	On	On	Off	On	Off	Off	244
On	On	On	On	Off	On	Off	On	245
On	On	On	On	Off	On	On	Off	246
On	On	On	On	Off	On	On	On	247
On	On	On	On	On	Off	Off	Off	248
On	On	On	On	On	Off	Off	On	249
On	On	On	On	On	Off	On	Off	250
On	On	On	On	On	Off	On	On	251
On	On	On	On	On	On	Off	Off	252
On	On	On	On	On	On	Off	On	253
On	On	On	On	On	On	On	Off	254
On	On	On	On	On	On	On	On	255

Appendix D - VCB-X BACnet Parameters

BACnet Properties for the VCB-X Controller					BACnet Properties for the VCB-X Controller						
Parameter	Name	Object	Description	Limits		Parameter	Name	Object	Description	Limits	
Alarm Group 1	AlmGrp1	AI: 104		See Alarm Group Bits on page 39.		CO ₂ Maximum Setpoint	CO2 MaxLv	AV:288	This is the CO ₂ level at which the Economizer Min Damper Position will be reset to the Economizer Max Position in High CO ₂ . In between the Min and Max CO ₂ levels the Economizer Min Damper Position will be proportionally reset between the configured Min Damper Position and the Max Position in High CO ₂ .	0	2000
Alarm Group 2	AlmGrp2	AI: 105		See Alarm Group Bits on page 39.							
Alarm Group 3	AlmGrp3	AI: 106		See Alarm Group Bits on page 39.							
Alarm Status	AlmSts	AI: 1	Indicates that there is an alarm.	0 = Off 1 = On See Alarm Group Bits on page 39.							
Application Software Version	AppVer	AI: 99	Current version of the software in the unit.			Coil Temperature	CoilTp	AI: 181	Current coil temperature reading.		
Unit Mode	UnitMode	AI:123		See Unit Mode Bits on page 39.							
Building Pressure	BuildPr	AI:272	Current value of the building pressure sensor.			Coil Temperature Offset	ColTpOft	AV:284	If the Coil Temperature Sensor is reading incorrectly, you can use this option to enter an offset temperature to adjust the Sensor's Temperature.	-100	100
Building Pressure Setpoint	RfPrSt	AV:118	Current Building Pressure Setpoint.	-20	.20						
CO ₂	CO2	AI:271	Current CO ₂ Level.			High Coil Temperature Setpoint	HiClTpSt	AV:296	This is the highest that the Coil Temperature will be reset to during Space Humidity Reset of the Coil Suction Temperature Setpoint. Produces a dew point in the supply air approximately 10°F above this setpoint.	35	70
CO ₂ Minimum Setpoint	CO2MinLv	AV:287	This is the threshold CO ₂ level at which the Economizer Min Damper Position Setpoint will begin to be reset higher.	0	2000						

Appendix D - VCB-X BACnet Parameters

BACnet Properties for the VCB-X Controller					
Parameter	Name	Object	Description	Limits	
Low Coil Temperature Setpoint	LoClTpSt	AV:295	This is the lowest that the Coil Temperature will be reset to during Space Humidity Reset of the Coil Suction Temperature Setpoint. Produces a dewpoint in the supply air approximately 10°F above this setpoint.	35	70
Condenser Control Signal	CdCtrSg1	AI:280	Condenser Fan Signal 1 Status.		
Control Status	CtrlSts	AI: 4	Current operational status.	See Control Status Bits on page 39.	
Control Temperature	CtrlTp	AI: 9	Current value of the control temperature sensor.		
Cooling Enabled	ClEnbl	AI: 6	Status that indicates mechanical cooling is enabled.		
Cooling Setpoint Mirror	ClSt	AI: 7	Occupied Cooling Mode Enable Setpoint Mirror.		
Dewpoint Setpoint	RhDewpSt	AV:282	On a MUA unit, if the outdoor dewpoint rises above this setpoint, the unit will activate Dehumidification.	35	80
Economizer Enabled	EcoEnbl	AI: 15	Status that indicates the economizer is enabled.		
Economizer Enable Setpoint	EcoEnbSt	AV:283	The economizer is enabled if the outdoor drybulb, dewpoint, or wetbulb temperature falls below this setpoint.	-30	80
Economizer Position	EcoPos	AI: 16	Current position of the economizer damper.		

BACnet Properties for the VCB-X Controller					
Parameter	Name	Object	Description	Limits	
Minimum Economizer Position	MinEcoSt	AV: 151	This is the minimum position of the economizer in the occupied mode.	0	100
Force Economizer	FrcEcono	AV: 267	Overrides all other Outdoor Air Damper position commands so as to maintain this fixed position. Configuring for "Auto" will restore normal unit control of the Outdoor Air Damper/Economizer operation.	0%	100%
				Auto=65535	
Exhaust Fan CFM	EtCFM	AI:194	Current Exhaust Airflow Measurement		
Exhaust Fan Speed	EtFnSpd	AI: 273	Current position of the VFD relief fan signal.		
Fan Starting Delay	FanDly	AI: 25	Indicates the current fan status related to request to run, fan starting delay or POF failure.	0=No Request 1=Fan Running 2=Fan Start Delay 3=POF Failure	
Force HVAC Mode	FrcHvacM	AV: 262	Overrides normal controller operation in order to force the unit into this desired mode. Configuring for "Auto" will restore normal unit control of the mode of operation.	0=Auto 1=Vent 2=Cool 3=Heat 4=Vent Dehum. 5=Cool Dehum. 6=Heat Dehum.	
Head Pressure	HeadPr	AI:276	Current value of the Head Pressure Reading.		
Head Pressure Setpoint	HeadPrSt	AI:279	Current Head Pressure Setpoint.		

Appendix D - VCB-X BACnet Parameters

BACnet Properties for the VCB-X Controller						BACnet Properties for the VCB-X Controller					
Parameter	Name	Object	Description	Limits		Parameter	Name	Object	Description	Limits	
Head Pressure Setpoint in Cooling Mode	CIHdPrSt	AV:293	This is the Head Pressure Setpoint the unit will control to in the Cooling Mode.	240 PSI	420 PSI	Modulating Cooling Position	MdCIPos	AI: 115	Current position of the modulating cooling signal (Chilled water or digital compressor).		
Head Pressure Setpoint in Reheat Mode	HtHdPrSt	AV:294	This is the Head Pressure Setpoint the unit will control to in the De-humidification Reheat Mode.	240 PSI	420 PSI	Modulating Gas Valve Position	MdGsVPos	AI:274	Current position of MODGAS modulating gas valve control.		
Heating Enabled	HtEnbl	AI: 30	Status that indicates that mechanical heating is enabled.			Modulating Heating Position	MdHtPos	AI: 116	Current position of the modulating heating signal (hot water or SCR heat).		
Heating Setpoint Mirror	HtSt	AI: 31	Occupied Heating Mode Enable Setpoint Mirror.			Morning Warm-Up Setpoint	WmupTg	AV:281	In a VAV application, upon entering the occupied mode, the Warm-up Demand will be activated if the return air temperature falls one degree below this setpoint.	50	90
Indoor Humidity	InRh	AI: 67	Current value of the indoor humidity sensor.			Occupied Cooling Setpoint	OcpCISt	AV: 42	If the control temperature rises one degree above this setpoint, the control will activate the cooling demand. If the control temperature is the Supply Air Sensor, then the cooling demand is always active.	1	110
Indoor Humidity Setpoint	InRhSt	AV:289	If Coil Temp Reset is being used this is also the lowest Space RH value that corresponds to the Hi Coil Temp Setpoint.	0	100	Occupied Heating Setpoint	OcpHtSt	AV: 43	If the control temperature drops one degree below this setpoint, the control will activate the heating demand. If the control temperature is the Supply Air Sensor, then there is no heating demand.	1	110
High Indoor Humidity Reset Limit	HiInRh	AV:292	During Coil Temp Reset, this is the highest Space RH value that corresponds to the Low Coil Temp Setpoint.	0	100						
Indoor Humidity Setpoint Mirror	InRhStM	AI: 114	Mirror of the InRhSt "read only."								
Leaving Water Temperature	LvWtrTp	AI:278	Leaving Water Temperature Value								
Low Ambient Relay Setpoint	LWAmbnt	AV:285	Temperature at which the Low Ambient Relay will activate in the Occupied or Unoccupied Mode.	-30	70						

Appendix D - VCB-X BACnet Parameters

BACnet Properties for the VCB-X Controller					
Parameter	Name	Object	Description	Limits	
Hood On Outdoor Air Cooling Setpoint	OaClSt	AV:45	This is the Cooling Mode Enable Setpoint used only in Hood On Mode.	1	110
Hood On Outdoor Air Heating Setpoint	OaHtSt	AV:46	This is the Heating Mode Enable Setpoint used only in Hood On Mode.	1	110
Outdoor Air CFM	OaCFM	AI: 193	Current Outdoor Airflow Measurement		
Minimum Desired Outdoor Air CFM	OACfmMin	AV:291	Minimum Outdoor Airflow CFM Setpoint	.10K	200K
Outdoor Humidity	OaRh	AI:52	Current value of the Outdoor Humidity Sensor.		
Outdoor Air Temperature	OaTp	AI: 54	Current value of the outdoor temperature sensor.		
Outdoor Air Temperature Offset	OaTpOst	AV: 53	If the Outdoor Temperature Sensor is reading incorrectly, you can use this option to enter an offset temperature to adjust the Sensor's Temperature.	-100	100
Preheat Relay Setpoint	PreHtAmb	AV:286	If the Supply Fan is energized this is the temperature at which the Preheat Relay will activate. Operates in the Occupied or Unoccupied Mode.	-30	70
Reheat Valve Position	RtVlvPos	AI:277	Current position of MHGRV modulating hot gas reheat valve.		

BACnet Properties for the VCB-X Controller					
Parameter	Name	Object	Description	Limits	
Return Air CFM	RaCFM	AI:275	Current Return Airflow Measurement.		
Return Air Temperature	RaTp	AI: 64	Current value of the return temperature sensor.		
Return Air Temperature Sensor Offset	RaTpOst	AV: 65	If the Return Temperature Sensor is reading incorrectly, you can use this option to enter an offset temperature to adjust the Sensor's Temperature.	-100	100
Schedule Force	SchdFrc	AV: 66	0 = Auto (uses controller's schedule) 1 = Forced Occupied 2 = Forced Unoccupied	0	2
Space Temperature	SpcTp	AI:72	Current value of the space temperature sensor.		
Space Temperature Offset	SpcTpOst	AV:71	If the Space Temperature Sensor is reading incorrectly, you can use this option to enter an offset temperature to adjust the Sensor's Temperature.	-100	100
Static Pressure	StaticPr	AI:270	Current Static Pressure.		
Static Pressure Setpoint	StatPrSt	AV:290	Current Static Pressure Setpoint.	.10	3.0
Supply Air CFM	SaCFM	AI:195	Current Supply Airflow Measurement.		
Supply Air Cooling Setpoint	SaClSt	AV:77	Supply Air Setpoint in Cooling Mode.	30	80
Supply Air Heating Setpoint	SaHtSt	AV:78	Supply Air Setpoint in Heating Mode.	40	240

Appendix D - VCB-X BACnet Parameters

BACnet Properties for the VCB-X Controller				
Parameter	Name	Object	Description	Limits
Supply Air Temperature	SaTp	AI:83	Current value of the supply air temperature sensor.	
Supply Air Temperature Offset	SaTpOst	AV:80	If the Supply Air Temperature Sensor is reading incorrectly, you can use this option to enter an offset temperature to adjust the Sensor's Temperature.	-100 100
Current Supply Air Temperature Setpoint	SaTpStM	AI: 82	Current SAT Cooling or Heating setpoint if there is no reset source; Current calculated SAT setpoint with Reset Source.	
Unoccupied Cooling Offset	UnClOst	AV:124	During the Unoccupied Mode of Operation, this Setpoint offsets the Occupied Cooling Setpoint out by this user adjustable amount. If you do not want Cooling to operate during the Unoccupied Mode, use the default setting of 30°F for this setpoint.	0 30

BACnet Properties for the VCB-X Controller				
Parameter	Name	Object	Description	Limits
Unoccupied Heating Offset	UnHtOst	AV:125	During the Unoccupied Mode of Operation, this Setpoint offsets the Occupied Heating Setpoint out by this user adjustable amount. If you do not want Heating to operate during the Unoccupied Mode, use the default setting of 30°F for this setpoint.	0 30
VFD Position	VfdBwPos	AI:88	Current position of the VFD blower fan signal.	
Remote VFD Position Setpoint	FrcFanSp	AV: 266	Override to force the VFD to this percentage speed. Configuring "Auto" will restore normal unit control of the VFD speed.	0% 100% Auto=65535
On Board Relay Status	OnRlys	AI:44		See page 39.
On Board Relay 1	OnRly1	BI: 127	Current status of VCB-X Main Board relay 1.	
On Board Relay 2	OnRly2	BI: 128	Current status of VCB-X Main Board relay 2.	
On Board Relay 3	OnRly3	BI: 129	Current status of VCB-X Main Board relay 3.	
On Board Relay 4	OnRly4	BI: 130	Current status of VCB-X Main Board relay 4.	
On Board Relay 5	OnRly5	BI: 131	Current status of VCB-X Main Board relay 5.	

Appendix D - VCB-X BACnet Parameters

BACnet Properties for the VCB-X Controller				
Parameter	Name	Object	Description	Limits
On Board Relay 6	OnRly6	BI:259	Current status of VCB-X Main Board relay 6.	
Expansion Module Relay 1	MnExRly1	BI:311	Current status of Relay 1 on the EM1 Expansion Module.	
Expansion Module Relay 2	MnExRly2	BI:312	Current status of Relay 2 on the EM1 Expansion Module.	
Expansion Module Relay 3	MnExRly3	BI:313	Current status of Relay 3 on the EM1 Expansion Module.	
Expansion Module Relay 4	MnExRly4	BI:314	Current status of Relay 4 on the EM1 Expansion Module.	
Expansion Module Relay 5	MnExRly5	BI:315	Current status of Relay 5 on the EM1 Expansion Module.	
12 Relay Expansion Module Relay 1	RIExRly1	BI:299	Current status of Relay 1 on the 12 Relay Expansion Module.	
12 Relay Expansion Module Relay 2	RIExRly2	BI:300	Current status of Relay 2 on the 12 Relay Expansion Module.	
12 Relay Expansion Module Relay 3	RIExRly3	BI:301	Current status of Relay 3 on the 12 Relay Expansion Module.	
12 Relay Expansion Module Relay 4	RIExRly4	BI:302	Current status of Relay 4 on the 12 Relay Expansion Module.	
12 Relay Expansion Module Relay 5	RIExRly5	BI:303	Current status of Relay 5 on the 12 Relay Expansion Module.	

BACnet Properties for the VCB-X Controller				
Parameter	Name	Object	Description	Limits
12 Relay Expansion Module Relay 6	RIExRly6	BI:304	Current status of Relay 6 on the 12 Relay Expansion Module.	
12 Relay Expansion Module Relay 7	RIExRly7	BI:305	Current status of Relay 7 on the 12 Relay Expansion Module.	
12 Relay Expansion Module Relay 8	RIExRly8	BI:306	Current status of Relay 8 on the 12 Relay Expansion Module.	
12 Relay Expansion Module Relay 9	RIExRly9	BI:307	Current status of Relay 9 on the 12 Relay Expansion Module.	
12 Relay Expansion Module Relay 10	RIExRly10	BI:308	Current status of Relay 10 on the 12 Relay Expansion Module.	
12 Relay Expansion Module Relay 11	RIExRly11	BI:309	Current status of Relay 11 on the 12 Relay Expansion Module.	
12 Relay Expansion Module Relay 12	RIExRly12	BI:310	Current status of Relay 12 on the 12 Relay Expansion Module.	

Appendix D - VCB-X BACnet Parameters

VCB-X PT-Link II BACnet®

Property Identifier:

The PT-Link II BACnet® Link amends the following property identity to the BACnet® property identifier.

BACNETPropertyIdentifier :**VcbxUnitMode ::= ENUMERATED {**

Unoccupied	(0)
Occupied	(1),
Override Mode	(2),
Holiday Unoccupied	(3),
Holiday Occupied	(4),
Forced Occupied	(5),
Forced Unoccupied	(6),
}	

VcbxControlStatusBits ::= ENUMERATED {

Off	(0),
Vent Mode	(1),
Cooling Mode	(2),
Heating Mode	(3),
Vent RH Mode	(4),
Cooling RH Mode	(5),
Heating RH Mode	(6),
Warm Up Mode	(7)
Defrost Mode	(8)
Purge Mode	(9)
}	

VcbxAlarmGroup1Bits ::= BIT STRING {

Bad Supply Air Sensor	(0),
Bad Return Air Sensor	(1),
Bad Outside Air Sensor	(2),
Bad Space Sensor	(3),
Bad Main Expansion Board	(4),
Bad Coil Temp Sensor	(5),
Bad Co2 Sensor	(6),
Bad Discharge Sensor	(7),
Bad OA CFM Sensor	(8),
Bad Exhaust CFM Sensor	(9),
Bad Supply CFM Sensor	(10),
Bad Return CFM Sensor	(11),
Bad Reheat Module	(12),
Bad ModGas Module	(13),
Bad Relay Expansion Module	(14)
}	

VcbxAlarmGroup2Bits ::= BIT STRING {

Mechanical Cooling Failure	(0),
Mechanical Heating Failure	(1),
Fan Proving Alarm	(2),
Dirty Filter Alarm	(3),
Emergency Shutdown Alarm	(4)
}	

VcbxAlarmGroup3Bits ::= BIT STRING {

High Supply Air Cutoff	(0),
Low Supply Air Cutoff	(1),
High Control Mode Signal Alarm	(2),
Low Control Mode Signal Alarm	(3),
Digital Compressor Cutoff Alarm	(4),
Digital Compressor Lockout Alarm	(5),
High Head Pressure	(6)
}	

VcbxOnBoardRelaysBits ::= BIT STRING {

On Board Relay 1	(0),
On Board Relay 2	(1),
On Board Relay 3	(2),
On Board Relay 4	(3),
On Board Relay 5	(4)
On Board Relay 6	(5)
}	

Appendix E - VCM-X Modular and WSHP BACnet Parameters

NOTE: The following points for the VCM-X Modular and VCM-X WSHP Controllers are additional points. All points and property identifiers in the VCM-X Controller table (pages 42-47) also apply to the VCM-X Modular and VCM-X WSHP Controllers.

BACnet Properties for VCM-X Modular

Parameter	Name	Object	Description	Limits	
Modulating Compressor 2	MdCmp2	AI: 206	Current position of the 2nd Stage of Compressor Modulation.		
Head Pressure 1	HdPr1	AI: 207	Head Pressure for 1st Compressor		
Head Pressure 2	HdPr2	AI: 208	Head Pressure for 2nd Compressor		
Condenser Fan 1	CdFan1	AI: 209	Condenser Fan 1 Signal Status		
Condenser Fan 2	CdFan2	AI: 210	Condenser Fan 2 Signal Status		
Remote VFD Reset	RmVFDPos	AV: 258	Remote VFD Position Reset	-1	100

BACnet Properties for VCM-X WSHP (Tulsa)

Parameter	Name	Object	Description	Limits	
Modulating Compressor 2	MdCmp2	AI: 206	Current position of the 2nd Stage of Compressor Modulation.		
Head Pressure 1	HdPr1	AI: 207	Head Pressure for 1st Compressor		
Head Pressure 2	HdPr2	AI: 208	Head Pressure for 2nd Compressor		
Condenser Fan 1	CdFan1	AI: 209	Condenser Fan 1 Signal Status		
Condenser Fan 2	CdFan2	AI: 210	Condenser Fan 2 Signal Status		
Water Temp. A	WaterTpA	AI: 220	Current water temperature of refrigerant for System A.		
Water Temp. B	WaterTpB	AI: 221	Current water temperature of refrigerant for System B.		
Remote VFD Reset	RmVFDPos	AV: 258	Remote VFD Position Reset	-1	100

BACnet Properties for VCM-X WSHP (Tulsa)

Parameter	Name	Object	Description	Limits	
Compressor A1 Low Suction Pressure Alarm	A1LSPAlm	BI: 222	Alarm that indicates Suction Pressure for Compressor A1 is below the Low Suction Pressure Cooling (Heating) Setpoint.		
Compressor A1 Lockout Alarm	A1LktAlm	BI: 223	Alarm that indicates Compressor A1 is locked out.		
Compressor A2 Low Suction Pressure Alarm	A2LSPAlm	BI: 224	Alarm that indicates Suction Pressure for Compressor A2 is below the Low Suction Pressure Cooling (Heating) Setpoint.		
Compressor A2 Lockout Alarm	A2LktAlm	BI: 225	Alarm that indicates Compressor A2 is locked out.		
Compressor B1 Low Suction Pressure Alarm	B1LSPAlm	BI: 226	Alarm that indicates Suction Pressure for Compressor B1 is below the Low Suction Pressure Cooling (Heating) Setpoint.		
Compressor B1 Lockout Alarm	B1LktAlm	BI: 227	Alarm that indicates Compressor B1 is locked out.		
Compressor B2 Low Suction Pressure Alarm	B2LSPAlm	BI: 228	Alarm that indicates Suction Pressure for Compressor B2 is below the Low Suction Pressure Cooling (Heating) Setpoint.		
Compressor 4 Lockout Alarm	B2LktAlm	BI: 229	Alarm that indicates Compressor B2 is locked out.		
Low Water Temperature 1 Alarm	LWT1Alm	BI: 230	Alarm that indicates water temperature is below the Leaving Water Safety Setpoint (Heating only) for System A.		

Appendix E - VCM-X Modular and WSHP BACnet Parameters

BACnet Properties for VCM-X WSHP (Tulsa)					
Parameter	Name	Object	Description	Limits	
Low Water Temperature 2 Alarm	LWT2Alm	BI: 231	Alarm that indicates water temperature is below the Leaving Water Safety Setpoint (Heating only) for System B		
Proof of Water 1 Flow Alarm	POWF1Alm	BI: 232	Alarm that indicates no Proof of Water Flow for System A (A1/A2)		
Proof of Water 2 Flow Alarm	POWF2Alm	BI: 233	Alarm that indicates no Proof of Water Flow for System B (B1/B2)		
Module Communications Alarm	ComMAlm	BI: 234	Alarm that indicates that one or more Modules are not communicating with the VCM-X WSHP Controller.		

BACnet Properties for VCM-X WSHP (Coil)					
Parameter	Name	Object	Description	Limits	
Compressor A Low Suction Pressure Alarm	A1LSPAIm	BI: 222	Alarm that indicates Suction Pressure for Circuit A is below the Low Suction Pressure Cooling (Heating) Setpoint.		
Compressor A Lockout Alarm	A1LktAlm	BI: 223	Alarm that indicates Circuit A Compressors are locked out.		
Compressor B Low Suction Pressure Alarm	B1LSPAIm	BI: 226	Alarm that indicates Suction Pressure for Circuit B is below the Low Suction Pressure Cooling (Heating) Setpoint.		
Compressor B Lockout Alarm	B1LktAlm	BI: 227	Alarm that indicates Circuit B Compressors are locked out.		
Low Water Temperature Alarm	LWT1Alm	BI: 230	Alarm that indicates water temperature is below the Leaving Water Safety Setpoint (Heating only).		
Proof of Water Flow Alarm	POWF1Alm	BI: 232	Alarm that indicates no Proof of Water Flow.		
Module Communications Alarm	ComMAlm	BI: 234	Alarm that indicates that one or more Modules are not communicating with the VCM-X WSHP Controller.		

BACnet Properties for VCM-X WSHP (Coil)					
Parameter	Name	Object	Description	Limits	
Modulating Compressor 2	MdCmp2	AI: 206	Current position of the 2nd Stage of Compressor Modulation.		
Head Pressure 1	HdPr1	AI: 207	Head Pressure for 1st Compressor		
Head Pressure 2	HdPr2	AI: 208	Head Pressure for 2nd Compressor		
Condenser Fan 1	CdFan1	AI: 209	Condenser Fan 1 Signal Status		
Condenser Fan 2	CdFan2	AI: 210	Condenser Fan 2 Signal Status		
Water Temp. A	WaterTpA	AI: 220	Current water temperature.		
Remote VFD Reset	RmVFDPoS	AV: 258	Remote VFD Position Reset	-1	100

Appendix F - VCM-X BACnet Parameters

BACnet Properties for the VCM-X Controller				
Parameter	Name	Object	Description	Limits
Alarm Status	AlmSts	AI: 1		See Alarm Group Bits on page 47.
Control Status	CtrlSts	AI: 4	Current operational status.	
Occupied/ Mode Enable Cooling Setpoint Mirror	ClSt	AI: 7	Occupied/ Mode Enable Cooling Setpoint Mirror.	
Control Temperature	CtrlTp	AI: 9	Current value of the control temperature sensor.	
Duct Static Pressure	DuctPr	AI: 14	Current value of the duct static pressure sensor.	
Economizer Position	EcoPos	AI: 16	Current position of the economizer damper.	
Occupied/ Mode Enable Heating Setpoint Mirror	HtSt	AI: 31	Occupied/ Mode Enable Heating Setpoint Mirror.	
Modulating Gas Valve Position	MdHt-2Pos	AI: 38	Current position of MODGAS II modulating gas valve control.	
On Board Relays	OnRlys	AI: 44		See page 47.
Outdoor Air Dewpoint	OaDwpt	AI: 47	Current calculated outdoor air dewpoint added on version 1.09.	
Outdoor Air Humidity	OaRh	AI: 52	Current value of the outdoor humidity sensor.	
Outdoor Air Temperature	OaTp	AI: 54	Current value of the outdoor temperature sensor.	
Outdoor Air Wetbulb	OaWtbl	AI: 55	Current calculated value of the outdoor wetbulb temperature.	
Reheat Value Position	Rt2Pos	AI: 60	Current position of MHGRV modulating hot gas reheat valve control.	
Relief Pressure	RfPr	AI: 62	Current value of the building pressure sensor.	
Return Air Temperature	RaTp	AI: 64	Current value of the return temperature sensor.	

BACnet Properties for the VCM-X Controller				
Parameter	Name	Object	Description	Limits
Indoor Humidity	InRh	AI: 67	Current value of the indoor humidity sensor.	
Space Temperature	SpcTp	AI: 72	Current value of the space temperature sensor.	
Current Supply Air Setpoint	SaTpStM	AI: 82	Current SAT Cooling or Heating setpoint if there is no reset source; Current calculated SAT setpoint with Reset Source.	
Supply Air Temperature	SaTp	AI: 83	Current value of the supply air temperature sensor.	
Temperature Demand	TpDmnd	AI: 84	Based on the comparison between the current Control Temperature and the Heating or Cooling Setpoint Temperatures. Does not work for supply air control	
VFD Blower Fan	VfdBw-Pos	AI: 88	Current position of the VFD blower fan signal.	
VFD Relief Fan	VfdExPos	AI: 89	Current position of the VFD relief fan signal.	
Application Software Version	AppVer	AI: 99	Current version of the software in the unit.	
Alarm Group 1	AlmGrp1	AI: 104		See Alarm Group Bits on page 47.
Alarm Group 2	AlmGrp2	AI: 105		See Alarm Group Bits on page 47.
Alarm Group 3	AlmGrp3	AI: 106		See Alarm Group Bits on page 47.
Dewpoint Setpoint Mirror	DptStM	AI: 110	Mirror of the DPtSt "read only."	
External Relays 1-2	ExRlys12	AI: 111		See page 47.
External Relays 3-4	ExRlys34	AI: 112		See page 47.
Indoor Rh Setpoint Mirror	InRhStM	AI: 114	Mirror of the InRhSt "read only."	

Appendix F - VCM-X BACnet Parameters

BACnet Properties for the VCM-X Controller					
Parameter	Name	Object	Description	Limits	
Modulating Cool Position	MdClPos	AI: 115	Current position of the modulating cooling signal (Chilled water or digital compressor).		
Modulating Heat Position	MdHtPos	AI: 116	Current position of the modulating heating signal (hot water or SCR heat).		
Unit Mode	UnitMode	AI: 123		See page 47.	
Return Air CO ₂ Level	CO2Level	AI: 150	Current value of the CO ₂ sensor.		
Bypass Damper Position	ByPas-Dmp	AI: 153	Current position of the bypass damper signal.		
Return Damper Position	RaDmp	AI: 154	Current position of the return damper signal.		
Coil Temperature	CoilTp	AI: 181	Current coil temperature reading added on version 1.09.		
Outdoor Air CFM	OaCFM	AI: 193	Current Outdoor Airflow Measurement		
Exhaust CFM	EtCFM	AI: 194	Current Exhaust Airflow Measurement		
Supply Air CFM	SaCFM	AI: 195	Current Supply Airflow Measurement		
Current Calculated OA CFM setpoint	OACfm-StM	AI: 205	Current calculated Outdoor Air CFM based on CO ₂ level.		
Dewpoint Setpoint	DptSt	AV: 13	If the outdoor dewpoint rises above this setpoint, the unit will activate the Dehumidification Demand.	35	80
Occupied/ Mode Enable Cooling Setpoint	OcpClSt	AV: 42	If the control temperature rises one degree above this setpoint, the control will activate the cooling demand. If the control temperature is the Supply Air Sensor, then the cooling demand is always active.	0	99

BACnet Properties for the VCM-X Controller					
Parameter	Name	Object	Description	Limits	
Occupied/ Mode Enable Heating Setpoint	OcpHtSt	AV: 43	If the control temperature drops one degree below this setpoint, the control will activate the heating demand. If the control temperature is the Supply Air Sensor, then there is no heating demand.	0	99
Outdoor Air Sensor Offset	OaTpOst	AV: 53	If the Outdoor Temperature Sensor is reading incorrectly, you can use this option to enter an offset temperature to adjust the Sensor's Temperature.	-100	100
Return Air Sensor Offset	RaTpOst	AV: 65	If the Return Temperature Sensor is reading incorrectly, you can use this option to enter an offset temperature to adjust the Sensor's Temperature.	-100	100
Schedule Force	SchDFrc	AV: 66	0 = Auto/ Unoccupied Mode 1 = Forced On 2 = Forced Off	0	2
Space Sensor Offset	SpTpOst	AV: 71	If the Space Temperature Sensor is reading incorrectly, you can use this option to enter an offset temperature to adjust the Sensor's Temperature.	-100	100
SAT Cooling Setpoint	SaClSt	AV: 77	Supply Air Setpoint in Cooling Mode.	40	80
SAT Heating Setpoint	SaHtSt	AV: 78	Supply Air Setpoint in Heating Mode.	40	200

Appendix F - VCM-X BACnet Parameters

BACnet Properties for the VCM-X Controller					
Parameter	Name	Object	Description	Limits	
Supply Air Sensor Offset	SaTpOst	AV: 80	If the Supply Air Temperature Sensor is reading incorrectly, you can use this option to enter an offset temperature to adjust the Sensor's Temperature.	-100	100
Warm Up Setpoint	WmupSt	AV: 91	In a VAV application, upon entering the occupied mode, the Warm-up Demand will be activated if the return air temperature falls one degree below this setpoint.	50	90
Wet Bulb Setpoint	WtblSt	AV: 92	The economizer is enabled if the outdoor temperature or wetbulb falls below this setpoint.	0	80
Coil Temperature Setpoint	CoilTpSt	AV: 107	This is the coil suction temperature target during dehumidification mode. Produces dewpoint in the supply air approximately 10°F above this setpoint.	35	70
Relief Pressure Setpoint	RfPrSt	AV: 118	This is the target building pressure to be maintained by the VFD Relief signal.	-0.2	0.2
Indoor Humidity Setpoint	InRhSt	AV: 120	If the indoor humidity rises above this setpoint, the unit will activate the Dehumidification Demand.	0	100
Unoccupied Cooling Offset	UnClOst	AV: 124	During the Unoccupied Mode of Operation, this Setpoint spreads the Occupied Cooling Setpoint out by a user adjustable amount. If you do not want Cooling to operate during the Unoccupied Mode, use the default setting of 30°F for these setpoints.	0	30

BACnet Properties for the VCM-X Controller					
Parameter	Name	Object	Description	Limits	
Unoccupied Heating Offset	UnHtOst	AV: 125	During the Unoccupied Mode of Operation, this Setpoint spreads the Occupied Heating Setpoint out by a user adjustable amount. If you do not want Heating to operate during the Unoccupied Mode, use the default setting of 30°F for these setpoints.	0	30
CO ₂ Setpoint	CO2St	AV: 149	When the CO ₂ level rises above the CO ₂ Protection Limit Max Level, the Economizer's Minimum Position will begin to reset open proportionally between the CO ₂ Protection Limit Max Level Setpoint and the Reset Range Setpoint.	0	3000
Minimum Outside Air Setpoint	MinEcoSt	AV: 151	This is the minimum position of the economizer in the occupied modes.	1	100
Static Pressure Setpoint	DuctPrSt	AV: 152	This is the target duct pressure to be maintained by the VFD blower signal.	0.01	3
Preheater Setpoint	PreHtSp	AV: 196	Low Outside Air Ambient Protection Setpoint	0	100
Outdoor Air CFM Setpoint	OACfmSt	AV: 203	Minimum desired Outdoor Air CFM.	0.10 K	200 K
Outdoor Air CFM Reset Limit	OACfmRs	AV: 204	Maximum desired Outdoor Air CFM when CO ₂ reaches its reset limit.	0.10 K	200 K

Appendix F - VCM-X BACnet Parameters

BACnet Properties for the VCM-X Controller				
Parameter	Name	Object	Description	Limits
Bad Supply Air Sensor	SaTpAlm	BI: 2	Alarm that indicates a failure in the supply air sensor.	
CO ₂ Sensor Installed	CO2Cfg	BI: 3	Status that indicates the CO ₂ function has been configured.	
Cooling Enabled	ClEnbl	BI: 6	Status that indicates mechanical cooling is enabled.	
Economizer Enabled	EcoEnbl	BI: 15	Status that indicates the economizer is enabled.	
Fan Start Up Delay	FanDly	BI: 25	Status that indicates the fan is commanded to run, but it is in the start up delay mode.	
Fan Proving Alarm	PofAlm	BI: 26	Alarm that indicates a failure in the flow of the VFD blower.	
Heating Enabled	HtEnbl	BI: 30	Status that indicates that mechanical heating is enabled.	
High Supply Air Temperature Alarm	HiSaAlm	BI: 33	The Supply Air has risen above the Hi SAT Cutoff Setpoint. Heating stages begin to deactivate and the fan continues to run.	
Low Supply Air Temperature Alarm	LoSaAlm	BI: 37	The Supply Air has fallen below the Hi SAT Cutoff Setpoint and cooling stages will begin to deactivate. If the unit is in Economizer, Vent, or Heating Mode the Supply Fan will shut off.	
MODGAS II Connected	MdHt2Ins	BI: 39	Status that indicates the MODGAS II controller is connected.	
Proof of Flow Configured	PofCfg	BI: 57	Status that indicates the proof of flow function has been configured.	
REHEAT II Connected	Rt2Ins	BI: 58	Status that indicates the MHGRV controllers is connected to the system.	

BACnet Properties for the VCM-X Controller				
Parameter	Name	Object	Description	Limits
Mechanical Cooling Alarm	MchClAlm	BI: 94	Compressor Relays are enabled but the Supply Air Temperature has not fallen 5°F w/in a user-adjustable time period. This does not indicate compressors are active and will not shut the unit down.	
Mechanical Heating Alarm	MchHtAlm	BI: 95	Heating Mode has been initiated but the Supply Air Temperature has not risen 5°F w/in a user-adjustable time period. This does not indicate heat stages are active and will not shut the unit down.	
Dirty Filter Detected	DrtFlAlm	BI: 96	Alarm that indicates the filters are dirty.	
Control Temperature Cool Failure	CtrlTpCF	BI: 108	This alarm is activated if the control temperature does not get within 5°F to the occupied cooling setpoint in an hour in the cooling mode. This alarm is not used in 100% outside air units or supply air control.	
Control Temperature Heat Failure	CtrlTpHF	BI: 109	This alarm is activated if the control temperature does not get within 5°F to the occupied heating setpoint in an hour in the heating mode. This alarm is not used in 100% outside air units or supply air control.	
Outdoor Air Temperature Lost	OaTpAlm	BI: 117	Alarm that indicates a failure in the outdoor air temperature.	
Smoke Detected Alarm	SmokeAlm	BI: 119	Alarm that indicates the Smoke sensor has been activated.	
Space Temperature Sensor Lost	SpcTpAlm	BI: 101	Alarm that indicates a failure in the space temperature sensor.	

Appendix F - VCM-X BACnet Parameters

BACnet Properties for the VCM-X Controller				
Parameter	Name	Object	Description	Limits
On Board Relay 1	OnRly1	BI: 127	Current status of relay 1.	
On Board Relay 2	OnRly2	BI: 128	Current status of relay 2.	
On Board Relay 3	OnRly3	BI: 129	Current status of relay 3.	
On Board Relay 4	OnRly4	BI: 130	Current status of relay 4.	
On Board Relay 5	OnRly5	BI: 131	Current status of relay 5.	
Expansion Relay 1	ExRly1	BI: 133	Current status of relay 6.	
Expansion Relay 2	ExRly2	BI: 134	Current status of relay 7.	
Expansion Relay 3	ExRly3	BI: 135	Current status of relay 8.	
Expansion Relay 4	ExRly4	BI: 136	Current status of relay 9.	
Expansion Relay 5	ExRly5	BI: 137	Current status of relay 10.	
Expansion Relay 6	ExRly6	BI: 138	Current status of relay 11.	
Expansion Relay 7	ExRly7	BI: 139	Current status of relay 12.	
Expansion Relay 8	ExRly8	BI: 140	Current status of relay 13.	
Expansion Relay 9	ExRly9	BI: 141	Current status of relay 14.	
Expansion Relay 10	ExRly10	BI: 142	Current status of relay 15.	
Expansion Relay 11	ExRly11	BI: 143	Current status of relay 16.	
Expansion Relay 12	ExRly12	BI: 144	Current status of relay 17.	
Expansion Relay 13	ExRly13	BI: 145	Current status of relay 18.	
Expansion Relay 14	ExRly14	BI: 146	Current status of relay 19.	
Expansion Relay 15	ExRly15	BI: 147	Current status of relay 20.	
Expansion Relay 16	ExRly16	BI: 148	Current status of relay 21.	

Appendix F - VCM-X BACnet Parameters

VCM-X PT-Link II BACnet®

Property Identifier:

The PT-Link II BACnet® Link amends the following property identity to the BACnet® property identifier.

BACNETPropertyIdentifier :

```
WattBACNETScheduleForce ::= ENUMERATED {
    NormalOperation           (0),
    ForceOccupied             (1),
    ForceUnoccupied           (2)
}
```

```
VcmxUnitMode ::= ENUMERATED {
    Unoccupied                 (0),
    RemoteContactOccupied     (1),
    NormalScheduleOccupied    (2),
    PushButtonOrZoneOverride  (3),
    HolidayModeActive         (4),
    UnoccupiedZoneDemand      (5),
    RemoteScheduleOverride    (6),
    CurrentOutputForceMode    (7),
    SATHighOrLowCutOff        (8),
    CO2OverrideInProgress     (9),
    PurgeModeActive           (10)
}
```

```
VcmxControlStatusBits ::= ENUMERATED {
    Off                        (0),
    Vent                       (1),
    Cool                       (2),
    Heat                       (3),
    Dehum                      (4),
    Dehum Cool                 (5),
    Dehum Heat                 (6),
    Warm Up Mode               (7)
}
```

```
VcmxOnBoardRelaysBits ::= BIT STRING {
    OnBoardRelay1             (0),
    OnBoardRelay2             (1),
    OnBoardRelay3             (2),
    OnBoardRelay4             (3),
    OnBoardRelay5             (4)
}
```

```
VcmxExternal Relays1-2Bits ::= BIT STRING {
    ExpansionBoard1Relay1     (0),
    ExpansionBoard1Relay2     (1),
    ExpansionBoard1Relay3     (2),
    ExpansionBoard1Relay4     (3),
    ExpansionBoard2Relay1     (4),
    ExpansionBoard2Relay2     (5),
    ExpansionBoard2Relay3     (6),
    ExpansionBoard2Relay4     (7)
}
```

```
VcmxExternal Relays2-4Bits ::= BIT STRING {
    ExpansionBoard3Relay1     (0),
    ExpansionBoard3Relay2     (1),
    ExpansionBoard3Relay3     (2),
    ExpansionBoard3Relay4     (3),
    ExpansionBoard4Relay1     (4),
    ExpansionBoard4Relay2     (5),
    ExpansionBoard4Relay3     (6),
    ExpansionBoard4Relay4     (7)
}
```

```
VcmxAlarmStatusBits ::= BIT STRING {
    Alarm Group1               (0),
    Alarm Group2               (1),
    Alarm Group3               (2)
}
```

```
VcmxAlarmGroup1Bits ::= BIT STRING {
    SupplyTempSensorFailure    (0),
    LostOutdoorTempSensorSignal (1),
    LostSpaceTempSensorSignal  (2)
}
```

```
VcmxAlarmGroup2Bits ::= BIT STRING {
    MechanicalCoolingAlarm     (0),
    MechanicalHeatingAlarm     (1),
    FanProvingAlarm            (2),
    DirtyFilterDetected        (3),
    SmokeDetected               (4)
}
```

```
VcmxAlarmGroup3Bits ::= BIT STRING {
    LowSupplyAirTempAlarm      (0),
    HighSupplyAirTempAlarm     (1),
    LowControlTempAlarm        (2),
    HighControlTempAlarm       (3)
}
```

Appendix G - SA Controller BACnet Parameters

BACnet Properties for SA Controller				
Parameter	Name	Object	Description	Limits
Control Status	CtrlSts	AI: 4	Current operational status.	
Occupied/ Mode Enable Cooling Setpoint Mirror	ClSt	AI: 7	Occupied/ Mode Enable Cooling Setpoint Mirror.	
Control Temperature	CtrlTp	AI: 9	Current value of the control temperature sensor.	
Duct Static Pressure	DuctPr	AI: 14	Current value of the duct static pressure sensor.	
Economizer Position	EcoPos	AI: 16	Current position of the economizer damper.	
Occupied/ Mode Enable Heating Setpoint Mirror	HtSt	AI: 31	Occupied/ Mode Enable Heating Setpoint Mirror.	
Modulating Gas Valve Position	MdHt-2Pos	AI: 38	Current position of MODGAS II modulating gas valve control.	
Reheat Value Position	Rt2Pos	AI: 60	Current position of MHGRV modulating hot gas reheat valve control.	
Indoor Humidity	InRh	AI: 67	Current value of the indoor humidity sensor.	
Space Temperature	SpcTp	AI: 72	Current value of the space temperature sensor.	
Current Supply Air Setpoint	SaTpStM	AI: 82	Current SAT Cooling or Heating setpoint if there is no reset source; Current calculated SAT setpoint with Reset Source.	
Supply Air Temperature	SaTp	AI: 83	Current value of the supply air temperature sensor.	
Temperature Demand	TpDmnd	AI: 84	Based on the comparison between the current Control Temperature and the Heating or Cooling Setpoint Temperatures. Does not work for supply air control	
VFD Blower Fan	VfdBw-Pos	AI: 88	Current position of the VFD blower fan signal.	

BACnet Properties for SA Controller				
Parameter	Name	Object	Description	Limits
Application Software Version	AppVer	AI: 99	Current version of the software in the unit.	
Coil Temperature Setpoint	CoilTpSt	AI: 107	Current Coil Temperature Setpoint.	
Dewpoint Setpoint Mirror	DptStM	AI: 110	Mirror of the DPTSt "read only."	
Indoor RH Setpoint Mirror	InRhStM	AI: 114	Mirror of the InRhSt "read only."	
Modulating Cool Position	MdClPos	AI: 115	Current position of the modulating cooling signal (Chilled water or digital compressor).	
Modulating Heat Position	MdHtPos	AI: 116	Current position of the modulating heating signal (hot water or SCR heat).	
Unit Mode	UnitMode	AI: 123		See Unit Mode Bits on page 51.
Coil Temperature	CoilTp	AI: 181	Current coil temperature reading added on version 1.09.	
Modulating Compressor 2 Position	MdCmp2	AI: 206	Current position of the 2nd Stage of Compressor Modulation.	
Head Pressure 1	HdPr1	AI: 207	Head Pressure for 1st unit.	
Head Pressure 2	HdPr2	AI: 208	Head Pressure for 2nd unit.	
Entering Air Temperature	EaTp	AI: 235	Temperature of the air that is entering the unit.	
Entering Water Temperature	EwTp	AI: 236	Temperature of the water that is entering the unit.	
Entering Air Humidity	EaRh	AI: 237	Relative Humidity of the Entering Air.	
Coil Temperature 2	CoilTp2	AI: 240	Current Coil Temperature for 2nd unit.	
Entering Air Dewpoint	EaDpt	AI: 241	Current Entering Air Dewpoint	
Water Side Economizer Bypass	WSEByp	AI: 242	Current Water Side Economizer Bypass Position for 1st unit.	
Water Side Economizer Bypass 2	WSEByp2	AI: 243	Current Water Side Economizer Bypass Position for 2nd unit.	
Condenser Position 1	CdPos1	AI: 246	Current Condenser Position for 1st unit.	

Appendix G - SA Controller BACnet Parameters

BACnet Properties for SA Controller					
Parameter	Name	Object	Description	Limits	
Condenser Position 2	CdPos2	AI: 247	Current Condenser Position for 2nd unit.		
Dewpoint Setpoint	DptSt	AV: 13	If the outdoor dewpoint rises above this setpoint, the unit will activate the Dehumidification Demand.	35	80
Occupied/ Mode Enable Cooling Setpoint	OcpClSt	AV: 42	If the control temperature rises one degree above this setpoint, the control will activate the cooling demand. If the control temperature is the Supply Air Sensor, then the cooling demand is always active.	0	99
Occupied/ Mode Enable Heating Setpoint	OcpHtSt	AV: 43	If the control temperature drops one degree below this setpoint, the control will activate the heating demand. If the control temperature is the Supply Air Sensor, then there is no heating demand.		99
Schedule Force	SchdFrc	AV: 66	0 = Auto/ Unoccupied Mode 1 = Forced On 2 = Forced Off	0	2
Space Sensor Offset	SpcTpOst	AV: 71	If the Space Temperature Sensor is reading incorrectly, you can use this option to enter an offset temperature to adjust the Sensor's Temperature.	-100	100
SAT Cooling Setpoint	SaClSt	AV: 77	Supply Air Setpoint in Cooling Mode.	40	80
SAT Heating Setpoint	SaHtSt	AV: 78	Supply Air Setpoint in Heating Mode.	40	200

BACnet Properties for SA Controller					
Parameter	Name	Object	Description	Limits	
Supply Air Sensor Offset	SaTpOst	AV: 80	If the Supply Air Temperature Sensor is reading incorrectly, you can use this option to enter an offset temperature to adjust the Sensor's Temperature.	-100	100
Warm Up Setpoint	WmupSt	AV: 91	In a VAV application, upon entering the occupied mode, the Warm-up Demand will be activated if the return air temperature falls one degree below this setpoint.	50	90
Coil Temperature Setpoint	CoilTpSt	AV: 107	This is the coil suction temperature target during dehumidification mode. Produces dewpoint in the supply air approximately 10°F above this setpoint.	35	70
Indoor Humidity Setpoint	InRhSt	AV: 120	If the indoor humidity rises above this setpoint, the unit will activate the Dehumidification Demand.	0	100
Unoccupied Cooling Offset	UnClOst	AV: 124	During the Unoccupied Mode of Operation, this Setpoint spreads the Occupied Cooling Setpoint out by a user adjustable amount. If you do not want Cooling to operate during the Unoccupied Mode, use the default setting of 30°F for these setpoints.	0	30

Appendix G - SA Controller BACnet Parameters

BACnet Properties for SA Controller					
Parameter	Name	Object	Description	Limits	
Unoccupied Heating Offset	UnHtOst	AV: 125	During the Unoccupied Mode of Operation, this Setpoint spreads the Occupied Heating Setpoint out by a user adjustable amount. If you do not want Heating to operate during the Unoccupied Mode, use the default setting of 30°F for these setpoints.	0	30
Static Pressure Setpoint	DuctPrSt	AV: 152	This is the target duct pressure to be maintained by the VFD blower signal.	0.01	3
Preheater Setpoint	PreHtSp	AV: 196	Low Outside Air Ambient Protection Setpoint	0	100
Entering Air Offset Setpoint	EaTpOst	AV: 238	If the Entering Air Temperature Sensor is reading incorrectly, you can use this option to enter an offset temperature to adjust the Sensor's Temperature.		
Entering Water Offset Setpoint	EwTpOst	AV: 239	If the Entering Water Temperature Sensor is reading incorrectly, you can use this option to enter an offset temperature to adjust the Sensor's Temperature.		
Bad Supply Air Sensor	SaTpAlm	BI: 2	Alarm that indicates a failure in the supply air sensor.		
Cooling Enabled	CIEnbl	BI: 6	Status that indicates mechanical cooling is enabled.		
Economizer Enabled	EcoEnbl	BI: 15	Status that indicates the economizer is enabled.		
Fan Start Up Delay	FanDly	BI: 25	Status that indicates the fan is commanded to run, but it is in the start up delay mode.		
Fan Proving Alarm	PofAlm	BI: 26	Alarm that indicates a failure in the flow of the VFD blower.		

BACnet Properties for SA Controller			
Parameter	Name	Object	Description
Heating Enabled	HtEnbl	BI: 30	Status that indicates that mechanical heating is enabled.
High Supply Air Temperature Alarm	HiSaAlm	BI: 33	The Supply Air has risen above the Hi SAT Cutoff Setpoint. Heating stages begin to deactivate and the fan continues to run.
Low Supply Air Temperature Alarm	LoSaAlm	BI: 37	The Supply Air has fallen below the Hi SAT Cutoff Setpoint and cooling stages will begin to deactivate. If the unit is in Economizer, Vent, or Heating Mode the Supply Fan will shut off.
MODGAS II Connected	MdHt2Ins	BI: 39	Status that indicates the MODGAS II controller is connected.
REHEAT II Connected	Rt2Ins	BI: 58	Status that indicates the MHGRV controllers is connected to the system.
Mechanical Cooling Alarm	MchClAlm	BI: 94	Compressor Relays are enabled but the Supply Air Temperature has not fallen 5°F w/in a user-adjustable time period. This does not indicate compressors are active and will not shut the unit down.
Mechanical Heating Alarm	MchHtAlm	BI: 95	Heating Mode has been initiated but the Supply Air Temperature has not risen 5°F w/in a user-adjustable time period. This does not indicate heat stages are active and will not shut the unit down.
Dirty Filter Detected	DrtFlAlm	BI: 96	Alarm that indicates the filters are dirty.
Control Temperature Cool Failure	CtrlTpCF	BI: 108	This alarm is activated if the control temperature does not get within 5°F to the occupied cooling setpoint in an hour in the cooling mode. This alarm is not used in 100% outside air units or supply air control.
Control Temperature Heat Failure	CtrlTpHF	BI: 109	This alarm is activated if the control temperature does not get within 5°F to the occupied heating setpoint in an hour in the heating mode. This alarm is not used in 100% outside air units or supply air control.
Space Temperature Sensor Lost	SpcTpAlm	BI: 101	Alarm that indicates a failure in the space temperature sensor.
On Board Relay 1	OnRly1	BI: 127	Current status of relay 1.
On Board Relay 2	OnRly2	BI: 128	Current status of relay 2.

Appendix G - SA Controller BACnet Parameters

BACnet Properties for SA Controller

Parameter	Name	Object	Description
On Board Relay 3	OnRly3	BI: 129	Current status of relay 3.
On Board Relay 4	OnRly4	BI: 130	Current status of relay 4.
On Board Relay 5	OnRly5	BI: 131	Current status of relay 5.
Expansion Relay 1	ExRly1	BI: 133	Current status of relay 6.
Expansion Relay 2	ExRly2	BI: 134	Current status of relay 7.
Expansion Relay 3	ExRly3	BI: 135	Current status of relay 8.
Expansion Relay 4	ExRly4	BI: 136	Current status of relay 9.
Expansion Relay 5	ExRly5	BI: 137	Current status of relay 10.
Expansion Relay 6	ExRly6	BI: 138	Current status of relay 11.
Expansion Relay 7	ExRly7	BI: 139	Current status of relay 12.
Expansion Relay 8	ExRly8	BI: 140	Current status of relay 13.
Expansion Relay 9	ExRly9	BI: 141	Current status of relay 14.
Expansion Relay 10	ExRly10	BI: 142	Current status of relay 15.
Expansion Relay 11	ExRly11	BI: 143	Current status of relay 16.
Expansion Relay 12	ExRly12	BI: 144	Current status of relay 17.
Expansion Relay 13	ExRly13	BI: 145	Current status of relay 18.
Expansion Relay 14	ExRly14	BI: 146	Current status of relay 19.
Expansion Relay 15	ExRly15	BI: 147	Current status of relay 20.
Expansion Relay 16	ExRly16	BI: 148	Current status of relay 21.
Emergency Shutdown Alarm	EmerAlm	BI: 219	Alarm that indicates Emergency Shutdown.
Drain Pan Overflow	DrnAlm	BI: 244	Alarm that indicates overflow of the drain pan.
Proof of Water Flow Alarm	PoWFAIm	BI: 245	Alarm that indicates no Proof of Water Flow.
Entering Air Temperature Alarm	EaTpAlm	BI: 248	Alarm that indicates failure in the Entering Air Temperature Sensor.

SA Controller PT-Link-BACnet®
Property Identifier:

The PT-Link-BACnet® Link amends the following property identity to the BACnet® property identifier.

BACNETPropertyIdentifier :**SAUnitMode ::= ENUMERATED {**

```

Unoccupied (0),
RemoteContactOccupied (1),
NormalScheduleOccupied (2),
PushButtonOrZoneOverride (3),
HolidayModeActive (4),
UnoccupiedZoneDemand (5),
RemoteScheduleOverride (6),
CurrentOutputForceMode (7),
SATHighOrLowCutOff (8),
CO2OverrideInProgress (9),
PurgeModeActive (10)
}

```

SAControlStatusBits ::= ENUMERATED {

```

Off (0),
Vent (1),
Cool (2),
Heat (3),
Dehum (4),
Dehum Cool (5),
Dehum Heat (6),
Warm Up Mode (7)
}

```

Appendix H - VCM BACnet Parameters

BACnet Properties for the VCM Controller				
Parameter	Name	Object	Description	Limits
Application Software Version	AppVer	AI: 99	Current version of the software in the unit.	
Alarm Status	AlmSts	AI: 1		See page 57.
Unit Mode	UnitMode	AI: 123		See page 57.
Control Status	CtrlSts	AI: 4	Current operational status.	
Control Temperature	CtrlTp	AI: 9	Current value of the control temperature sensor.	
Occupied/ Mode Enable Cooling Setpoint Mirror	ClSt	AI: 7	Occupied/ Mode Enable Cooling Setpoint Mirror.	
Duct Static Pressure	DuctPr	AI: 14	Current value of the duct static pressure sensor.	
Economizer Position	EcoPos	AI: 16	Current position of the economizer damper.	
External Relays 1-2	ExRlys12	AI: 111		See page 57.
External Relays 3-4	ExRlys34	AI: 112		See page 57.
Indoor Humidity	InRh	AI: 67	Current value of the indoor humidity sensor.	
Occupied/ Mode Enable Heating Setpoint Mirror	HtSt	AI: 31	Occupied/ Mode Enable Heating Setpoint Mirror.	
On Board Relays	OnRlys	AI: 44		See page 57.
Outdoor Air Humidity	OaRh	AI: 52	Current value of the outdoor humidity sensor.	
Outdoor Air Temperature	OaTp	AI: 54	Current value of the outdoor temperature sensor.	
Outdoor Air Wetbulb	OaWtbl	AI: 55	Current calculated value of the outdoor wetbulb temperature.	
Relief Pressure	RfPr	AI: 62	Current value of the building pressure sensor.	
Return Air CO ₂ Level	CO2Level	AI: 150	Current value of the CO ₂ sensor.	
Return Air Temperature	RaTp	AI: 64	Current value of the return temperature sensor.	
Space Temperature	SpcTp	AI: 72	Current value of the space temperature sensor.	

BACnet Properties for the VCM Controller				
Parameter	Name	Object	Description	Limits
Supply Air Temperature	SaTp	AI: 83	Current value of the supply air temperature sensor.	
Temperature Demand	TpDmnd	AI: 84	Based on the comparison between the current Control Temperature and the Heating or Cooling Setpoint Temperatures. Does not work for supply air control.	
VFD Blower Fan	VfdBwPos	AI: 88	Current position of the VFD blower fan signal.	
VFD Relief Fan	VfdExPos	AI: 89	Current position of the VFD relief fan signal.	
Modulating Gas Valve Position	MdHt2Pos	AI: 38	Current position of MODGAS II modulating gas valve control.	
Reheat Value Position	Rt2Pos	AI: 60	Current position of MHGRV modulating hot gas reheat valve control.	
Alarm Group 1	AlrmGrp1	AI: 104		See page 57.
Alarm Group 2	AlrmGrp2	AI: 105		See page 57.
Alarm Group 3	AlrmGrp3	AI: 106		See page 57.
Dewpoint Setpoint Mirror	DptStM	AI: 110	Mirror of the DptSt "read only."	
Indoor RH Setpoint Mirror	InRhStM	AI: 114	Mirror of the InRhSt "read only."	
Modulating Cool Position	MdClPos	AI: 115	Current position of the modulating cooling signal (Chilled water or digital compressor).	
Modulating Heat Position	MdHtPos	AI: 116	Current position of the modulating heating signal (hot water or SCR heat).	

Appendix H - VCM BACnet Parameters

BACnet Properties for the VCM Controller					
Parameter	Name	Object	Description	Limits	
Bypass Damper Position	ByPasDmp	AI: 153	Current position of the bypass damper signal.		
Return Damper Position	RaDmp	AI: 154	Current position of the return damper signal.		
Outdoor Air Dewpoint	OaDwpt	AI: 47	Current calculated outdoor air dewpoint added on version 1.09.		
Current Supply Air Setpoint	SaTpStM	AI: 82	Current SAT Cooling or Heating setpoint if there is no reset source; Current calculated SAT setpoint with Reset Source.		
Coil Temperature	CoilTp	AI: 181	Current coil temperature reading added on version 1.09.		
Preheater Setpoint	PreHtSp	AV: 196	Low Outside Air Ambient Protection Setpoint	0	100
CO ₂ Setpoint	CO2St	AV: 149	When the CO ₂ level rises above the CO ₂ Protection Limit Max Level, the Economizer's Minimum Position will begin to reset open proportionally between the CO ₂ Protection Limit Max Level Setpoint and the Reset Range Setpoint.	0	3000
Static Pressure Setpoint	DuctPrSt	AV: 152	This is the target duct pressure to be maintained by the VFD blower signal.	0.01	3
Minimum Outside Air Setpoint	MinEcoSt	AV: 151	This is the minimum position of the economizer in the occupied modes.	1	100

BACnet Properties for the VCM Controller					
Parameter	Name	Object	Description	Limits	
Occupied/ Mode Enable Cooling Setpoint	OcpClSt	AV: 42	If the control temperature rises one degree above this setpoint, the control will activate the cooling demand. If the control temperature is the Supply Air Sensor, then the cooling demand is always active.	0	99
Occupied/ Mode Enable Heating Setpoint	OcpHtSt	AV: 43	If the control temperature drops one degree below this setpoint, the control will activate the heating demand. If the control temperature is the Supply Air Sensor, then there is no heating demand.	0	99
Outdoor Air Sensor Offset	OaTpOst	AV: 53	If the Outdoor Temperature Sensor is reading incorrectly, you can use this option to enter an offset temperature to adjust the Sensor's Temperature.	-100	100
Relief Pressure Setpoint	RfPrSt	AV: 118	This is the target building pressure to be maintained by the VFD Relief signal.	-0.2	0.2
Return Air Sensor Offset	RaTpOst	AV: 65	If the Return Temperature Sensor is reading incorrectly, you can use this option to enter an offset temperature to adjust the Sensor's Temperature.	-100	100

Appendix H - VCM BACnet Parameters

BACnet Properties for the VCM Controller					
Parameter	Name	Object	Description	Limits	
Schedule Force	SchdFrc	AV: 66	0 = Auto/ Unoccupied Mode 1 = Forced On 2 = Forced Off	0	2
Space Sensor Offset	SpcTpOst	AV: 71	If the Space Temperature Sensor is reading incorrectly, you can use this option to enter an offset temperature to adjust the Sensor's Temperature.	-100	100
SAT/Reset Source Cooling Setpoint	SaClSt	AV: 77	Supply Air setpoint or Reset Source target temperature in Cooling Mode.	40	80
SAT/Reset Source Heating Setpoint	SaHtSt	AV: 78	Supply Air setpoint or Reset Source target temperature in Heating Mode.	40	200
Supply Air Sensor Offset	SaTpOst	AV: 80	If the Supply Air Temperature Sensor is reading incorrectly, you can use this option to enter an offset temperature to adjust the Sensor's Temperature.	-100	100
Unoccupied Cooling Offset	UnClOst	AV: 124	During the Unoccupied Mode of Operation, this Setpoint spreads the Occupied Cooling Setpoint out by a user adjustable amount. If you do not want Cooling to operate during the Unoccupied Mode, use the default setting of 30°F for these setpoints.	0	30
Unoccupied Heating Offset	UnHtOst	AV: 125	During the Unoccupied Mode of Operation, this Setpoint spreads the Occupied Heating Setpoint out by a user adjustable amount. If you do not want Heating to operate during the Unoccupied Mode, use the default setting of 30°F for these setpoints.	0	30

BACnet Properties for the VCM Controller					
Parameter	Name	Object	Description	Limits	
Dewpoint Setpoint	DptSt	AV: 13	If the outdoor dewpoint rises above this setpoint, the unit will activate the Dehumidification Demand.	35	80
Coil Temperature Setpoint	CoilTpSt	AV: 107	This is the coil suction temperature target during dehumidification mode. Produces dewpoint in the supply air approximately 10°F above this setpoint.	35	70
Indoor Humidity Setpoint	InRhSt	AV: 120	If the indoor humidity rises above this setpoint, the unit will activate the Dehumidification Demand.	0	100
Warm Up Setpoint	WmupSt	AV: 91	In a VAV application, upon entering the occupied mode, the Warm-up Demand will be activated if the return air temperature falls one degree below this setpoint.	50	90
Wet Bulb Setpoint	WtblSt	AV: 92	The economizer is enabled if the outdoor temperature or wetbulb falls below this setpoint.	0	80
Bad Supply Air Sensor	SaTpAlm	BI: 2	Alarm that indicates a failure in the supply air sensor.		
CO ₂ Sensor Installed	CO2Cfg	BI: 3	Status that indicates the CO ₂ function has been configured.		
Cooling Demand	ClDmnd	BI: 5	Status that indicates a demand for cooling.		
Cooling Enabled	ClEnbl	BI: 6	Status that indicates mechanical cooling is enabled.		
Economizer Enabled	EcoEnbl	BI: 15	Status that indicates the economizer is enabled.		

Appendix H - VCM BACnet Parameters

BACnet Properties for the VCM Controller				
Parameter	Name	Object	Description	Limits
Fan Start Up Delay	FanDly	BI: 25	Status that indicates the fan is commanded to run, but it is in the start up delay mode.	
Fan Proving Alarm	PofAlm	BI: 26	Alarm that indicates a failure in the flow of the VFD blower.	
Heating Demand	HtDmnd	BI: 29	Status that indicates a demand for heating.	
Heating Enabled	HtEnbl	BI: 30	Status that indicates that mechanical heating is enabled.	
High Supply Air Temperature Alarm	HiSaAlm	BI: 33	The Supply Air has risen above the Hi SAT Cutoff Setpoint. Heating stages begin to deactivate and the fan continues to run.	
Low Supply Air Temperature Alarm	LoSaAlm	BI: 37	The Supply Air has fallen below the Hi SAT Cutoff Setpoint and cooling stages will begin to deactivate. If the unit is in Economizer, Vent, or Heating Mode the Supply Fan will shut off.	
MODGAS II Connected	MdHt2Ins	BI: 39	Status that indicates the MODGAS II controller is connected.	
Proof of Flow Configured	PofCfg	BI: 57	Status that indicates the proof of flow function has been configured.	
REHEAT II Connected	Rt2Ins	BI: 58	Status that indicates the MHGRV controllers is connected to the system.	
Warm Up Mode Active	WmupDmnd	BI: 90	Status that indicates the control is in the Warm-up mode.	
Mechanical Cooling Alarm	MchClAlm	BI: 94	Compressor Relays are enabled but the Supply Air Temperature has not fallen 5°F w/in a user-adjustable time period. This does not indicate compressors are active and will not shut the unit down.	

BACnet Properties for the VCM Controller				
Parameter	Name	Object	Description	Limits
Mechanical Heating Alarm	MchHtAlm	BI: 95	Heating Mode has been initiated but the Supply Air Temperature has not risen 5°F w/in a user-adjustable time period. This does not indicate heat stages are active and will not shut the unit down.	
Dirty Filter Detected	DrtFlAlm	BI: 96	Alarm that indicates the filters are dirty.	
Control Temperature Cool Failure	CtrlTpCF	BI: 108	This alarm is activated if the control temperature does not get within 5°F to the occupied cooling setpoint in an hour in the cooling mode. This alarm is not used in 100% outside air units or supply air control.	
Control Temperature Heat Failure	CtrlTpHF	BI: 109	This alarm is activated if the control temperature does not get within 5°F to the occupied heating setpoint in an hour in the heating mode. This alarm is not used in 100% outside air units or supply air control.	
Dehumidification Demand	DehmDmnd	BI: 113	Status that indicates a demand for dehumidification.	
Outdoor Air Temperature Lost	OaTpAlm	BI: 117	Alarm that indicates a failure in the outdoor air temperature.	
Smoke Detected Alarm	SmokeAlm	BI: 119	Alarm that indicates the Smoke sensor has been activated.	
Space Temperature Sensor Lost	SpcTpAlm	BI: 101	Alarm that indicates a failure in the space temperature sensor.	
On Board Relay 1	OnRly1	BI: 127	Current status of relay 1.	
On Board Relay 2	OnRly2	BI: 128	Current status of relay 2.	
On Board Relay 3	OnRly3	BI: 129	Current status of relay 3.	
On Board Relay 4	OnRly4	BI: 130	Current status of relay 4.	

Appendix H - VCM BACnet Parameters

BACnet Properties for the VCM Controller				
Parameter	Name	Object	Description	Limits
On Board Relay 5	OnRly5	BI: 131	Current status of relay 5.	
Expansion Relay 1	ExRly1	BI: 133	Current status of relay 6.	
Expansion Relay 2	ExRly2	BI: 134	Current status of relay 7.	
Expansion Relay 3	ExRly3	BI: 135	Current status of relay 8.	
Expansion Relay 4	ExRly4	BI: 136	Current status of relay 9.	
Expansion Relay 5	ExRly5	BI: 137	Current status of relay 10.	
Expansion Relay 6	ExRly6	BI: 138	Current status of relay 11.	
Expansion Relay 7	ExRly7	BI: 139	Current status of relay 12.	
Expansion Relay 8	ExRly8	BI: 140	Current status of relay 13.	
Expansion Relay 9	ExRly9	BI: 141	Current status of relay 14.	
Expansion Relay 10	ExRly10	BI: 142	Current status of relay 15.	
Expansion Relay 11	ExRly11	BI: 143	Current status of relay 16.	
Expansion Relay 12	ExRly12	BI: 144	Current status of relay 17.	
Expansion Relay 13	ExRly13	BI: 145	Current status of relay 18.	
Expansion Relay 14	ExRly14	BI: 146	Current status of relay 19.	
Expansion Relay 15	ExRly15	BI: 147	Current status of relay 20.	
Expansion Relay 16	ExRly16	BI: 148	Current status of relay 21.	

Appendix H - VCM BACnet Parameters

VCM PT-Link II BACnet®

Property Identifier:

The PT-Link II BACnet® Link amends the following property identity to the BACnet® property identifier.

BACNETPropertyIdentifier :**WattBACNETScheduleForce ::= ENUMERATED {**

```

NormalOperation          (0),
ForceOccupied           (1),
ForceUnoccupied         (2)
}

```

VcmUnitMode ::= ENUMERATED {

```

Unoccupied              (0),
RemoteContactOccupied  (1),
NormalScheduleOccupied (2),
PushButtonOrZoneOverride (3),
HolidayModeActive      (4),
UnoccupiedZoneDemand   (5),
RemoteScheduleOverride (6),
CurrentOutputForceMode (7),
SATHighOrLowCutOff     (8),
CO2OverrideInProgress  (9),
PurgeModeActive        (10)
}

```

VcmControlStatusBits ::= BIT STRING {

```

AhuControlEconomizer    (0),
NoOutdoorAirTempSensor  (1),
CarbonDioxideSensorPresent (2),
HeatCoolStagingDisabled (3),
DehumidificationMode    (4),
ModGasIIConnected       (5),
ReheatIIConnected       (6)
}

```

VcmOnBoardRelaysBits ::= BIT STRING {

```

OnBoardRelay1          (0),
OnBoardRelay2          (1),
OnBoardRelay3          (2),
OnBoardRelay4          (3),
OnBoardRelay5          (4)
}

```

VcmExternal Relays1-2Bits ::= BIT STRING {

```

ExpansionBoard1Relay1  (0),
ExpansionBoard1Relay2  (1),
ExpansionBoard1Relay3  (2),
ExpansionBoard1Relay4  (3),
ExpansionBoard2Relay1  (4),
ExpansionBoard2Relay2  (5),
ExpansionBoard2Relay3  (6),
ExpansionBoard2Relay4  (7)
}

```

VcmExternal Relays2-4Bits ::= BIT STRING {

```

ExpansionBoard3Relay1  (0),
ExpansionBoard3Relay2  (1),
ExpansionBoard3Relay3  (2),
ExpansionBoard3Relay4  (3),
ExpansionBoard4Relay1  (4),
ExpansionBoard4Relay2  (5),
ExpansionBoard4Relay3  (6),
ExpansionBoard4Relay4  (7)
}

```

VcmAlarmStatusBits ::= BIT STRING {

```

Alarm Group1           (0),
Alarm Group2           (1),
Alarm Group3           (2)
}

```

Notes



Form: OR-PTLNK2BTL-TGD-01E
All rights reserved.

Printed in the USA

January 2012
Copyright 2012

WattMaster Controls, Inc. • 8500 NW River Park Drive • Parkville, MO • 64152
Phone (816) 505-1100 www.orioncontrols.com Fax (816) 505-1101