

PT-Link II N2[®] Technical Guide

VCM-X Controller Code: SS1026 & Y200920 Version 2.0 and up;
 VCM-X Modular Controller Code: SS1030 & SS1034
 VCM-X WSHP Controller Code: SS1032 & SS1033
 SA Controller Code: Y200921
 VCM Controller Code: SS1016, Y200409, Y200616, Y200822



Table of Contents

General Information.....	3
Data Sharing	3
Scheduling.....	3
Hardware Specifications	3
System Requirements.....	3
Dimensions and Components	4
Quick Guide.....	4
Connection and Wiring Information	5
Configuring the PT-Link II Controller.....	6
PT-Link II Hardware Connection	6
Computer IP Address Set-up for Windows NT & XP	7
Computer IP Address Set-up for Windows Vista & 7	8
Connecting to the PT-Link.....	9
Making Changes to the Configuration File (config.csv).....	10
Downloading Config.csv to the PT-Link.....	11
Troubleshooting the PT-Link II Controller.....	13
Addressing WattMaster Devices in an N2® Network.	13
PT-Link II Board LEDs.....	14
ProtoCessor Module LEDs.....	15
Troubleshooting Using RUINET	16
Verifying Proper Communications	16
Verifying Proper Values	16
Updating the PT-Link II Controller.....	17
Data Arrays	21
Table 2: VCM-X Modular Data Array for Field Server.....	21
Table 3: VCM-X WSHP (Tulsa) Data Array for Field Server.....	21
Table 4: VCM-X WSHP (Coil) Data Array for Field Server	22
Table 5: VCM-X Data Array for Field Server.....	22
Table 6: SA Controller Data Array for Field Server	23
Table 7: VCM Data Array For Field Server	23
Appendix A.....	24
Figure 25: RJ-45 8P8C Cable for WattMaster Cross Over Networking - WattMaster Part #HZ000136.....	24
Appendix B VCM-X Modular and VCM-X WSHP N2 Parameters.....	25
Appendix C - VCM-X N2 Parameters	27
Appendix D - SA Controller N2 Parameters	33
Appendix E - VCM N2 Parameters	37

WattMaster Controls, Inc.
8500 NW River Park Drive · Parkville, MO 64152
Toll Free Phone: 866-918-1100
PH: (816) 505-1100 · FAX: (816) 505-1101 · E-mail: mail@wattmaster.com
Visit our web site at www.orioncontrols.com
Form: OR-PTLNK-II-N2-TGD-01E Copyright August 2011 WattMaster Controls, Inc.
N2® is a registered trademark of Johnson Controls, Inc.
WattMaster Controls, Inc. assumes no responsibility for errors, or omissions.
This document is subject to change without notice.

The OE368-23-N2, PT-Link II N2[®] provides bi-directional communication between your N2[®] protocol network and up to four* of any of the following types of Orion controllers—VCM-X, SA, VCM, MUA II, or VAV/CAV:

VCM-X Controller (SS1026, SS1030, SS1032, SS1033, SS1034, Y200920)

SA Controller (Y200921)

VCM Controller (SS1016, Y200409, Y200616, Y200822)

**MUA II Controller (Y200405); VAV/CAV Controller (Y200301)

To determine what controller you have, you must look at the label located on the controller EPROM. If the controller label does not match any of the SS or Y numbers listed above, your controller will not work with the PT-Link II N2[®].

*NOTE: The PT-Link II N2[®] device can be used to connect to only four Orion controllers. If more than four Orion controllers are present in a system, you will need one or more additional PT-Link II N2[®] devices for integration with an N2[®] protocol network.

**NOTE: Documentation is available for MUA II/VAV/CAV on our Orion Controls website: www.orioncontrols.com/literature-new.html

Data Sharing

The PT-Link II N2[®] interface provides the following data sharing capabilities:

- Provides values from points on the Orion side of the gateway to N2[®] devices as if the values were originating from N2[®] objects.
- Allows N2[®] devices to modify point values on the Orion controller side of the PT-Link II N2[®] by using standard N2[®] write services.

Scheduling

- Ability to allow N2[®] devices to send Schedule events to the Orion controller side of the gateway by using standard N2[®] services.

Hardware Specifications

Table 1 contains the hardware specifications for the PT-Link II N2[®] interface.

Technical Data	
N2 [®] Loop	9600, 19200, 38400, 76800 Mbps
Controller Loop	RS-485, 9600 Baud Rate
Protocol (N2 [®] Loop)	Metasys [®] N2 Open
Protocol (WattMaster Loop)	HSI Open Protocol Token Passing
Power Input Voltage	24 VAC
Power Consumption	10 VA Maximum
Operating Temp	-30°F to 150°F
Operating Humidity	90% RH Non-Condensing
Weight	4.5 oz.
Device Type	External Vendor Device

Table 1: PT-Link II N2[®] Interface Technical Data

System Requirements

- The PT-Link II N2[®] interface is packaged and assembled as surface mount. Surface mount components are included for your convenience.
- Computer running Microsoft Windows[™] operating system.
- Ethernet Crossover Cable (supplied).
- PT-Link II N2 software and RUINET software—located on the PT-Link II CD-ROM and downloadable from www.orioncontrols.com/software-new.html.

Setting Up Your PT-Link

Quick Guide

The following steps will get you up and running in no time:

1. Familiarize yourself with the PT-Link II components (**Figure 1**).
2. Connect your PT-Link II to the Controller(s) on your system (up to four) and connect your PT-Link II to the N2 Network (**Figure 2**).
3. Copy the contents of the PT Link CD to your PC's Desktop. You can also download the files from <http://orioncontrols.com/software-new.html> under PT-Link II Setup Files. These files include RUIINET.
4. Connect your PT-Link II to your computer using an Ethernet connection (**Figures 3 & 4**).
5. Change your PC's IP Address. Follow the directions that match your current operating system - Windows NT, XP, Vista, or 7. See directions on **pages 7 & 8**.
6. Obtain the following from your Building Automation System Integrator: the N2 MAC address (System Node ID) and the Client Node ID.
7. Using RUIINET, edit the Config.csv file and verify PT Link communications. Follow the directions on **pages 9-12**.
8. If you run into any problems, follow the instructions in the Troubleshooting section starting on **page 13** of this guide.

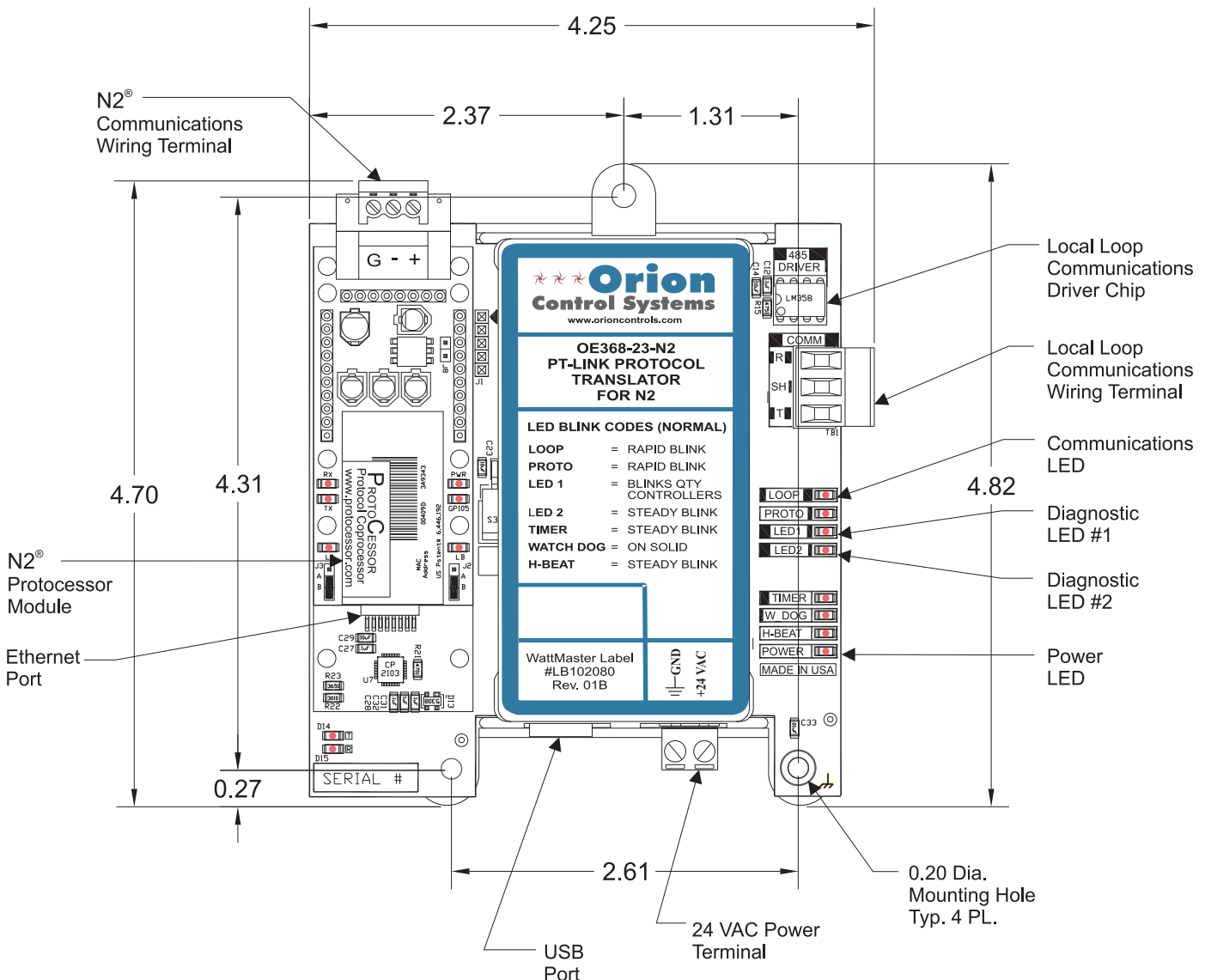

Figure 1: PT-Link II N2® Dimensions and Components

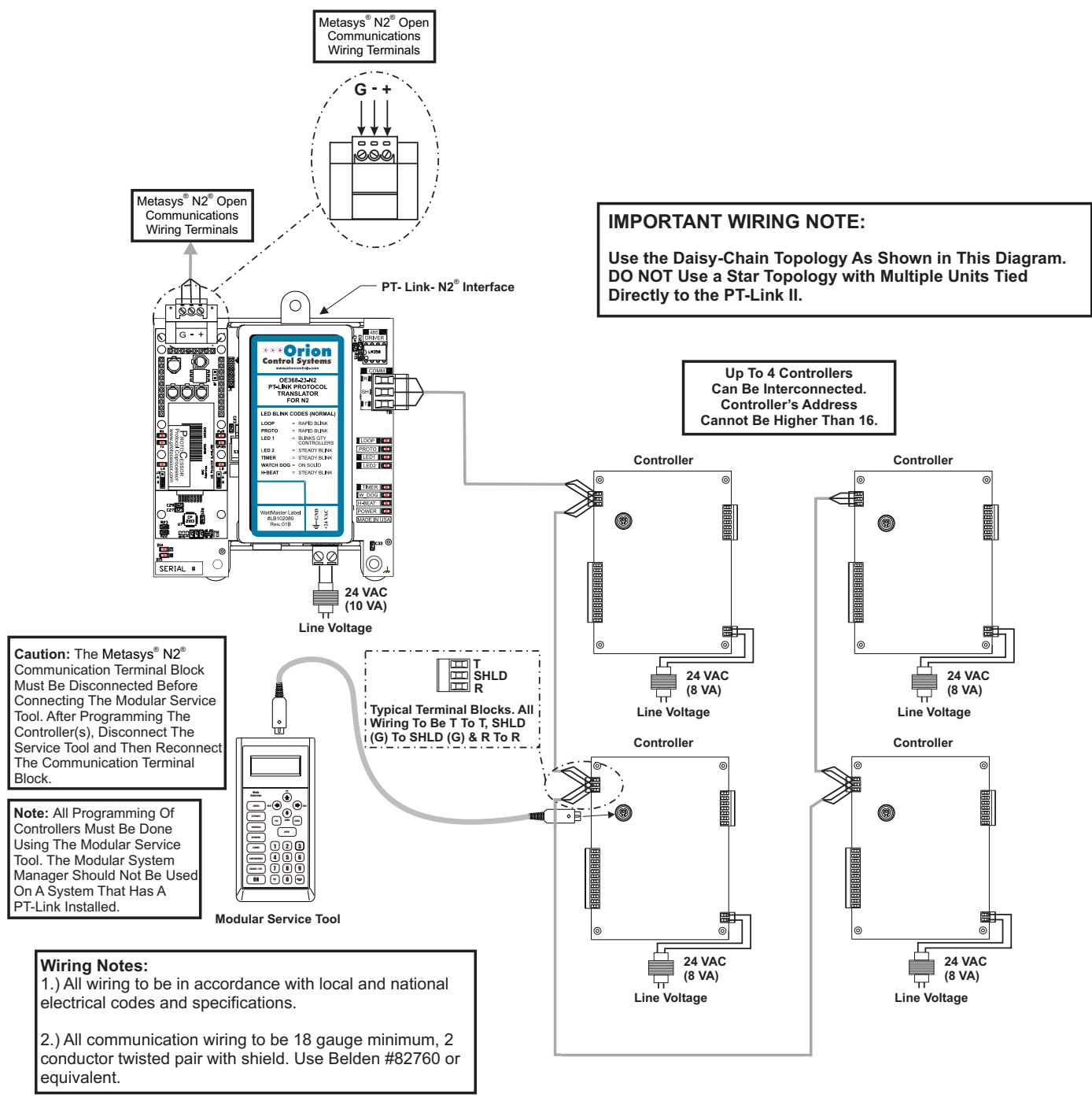

Figure 2: PT-Link II N2[®] Interface Wiring

PT-Link II Ethernet Connection

PT-Link II Hardware Connection

You have two options for connecting the PT-Link II to your PC via Ethernet:

- 1.) You may connect the PT-Link II directly to your PC by using a crossover cable (by others) as shown. **See Figure 3** for details.
- 2.) You can also connect both your PC and the PT-Link II to an Ethernet Hub with standard CAT5 cables. **See Figure 4** for details.

Locate a CAT5 cable and plug one end into your computer's Ethernet port (use a crossover cable if connecting directly to the PT-Link). If connecting directly, plug the other end of the Cable into the Ethernet port on the PT-Link. If connecting through an Ethernet Hub, plug the other end of the PC cable into the hub, and use a second CAT5 cable to connect the PT-Link II to the hub as well.

Power up the PT-Link II by plugging in the power cable. The PT-Link II may take up to three minutes to power up completely. Once the PT-Link II is powered up, you should notice that the green "GPI05" LED light on the ProtoCessor Board remains on continuously. **See Figure 13** for a diagram showing the location of the ProtoCessor "GPI05" LED.

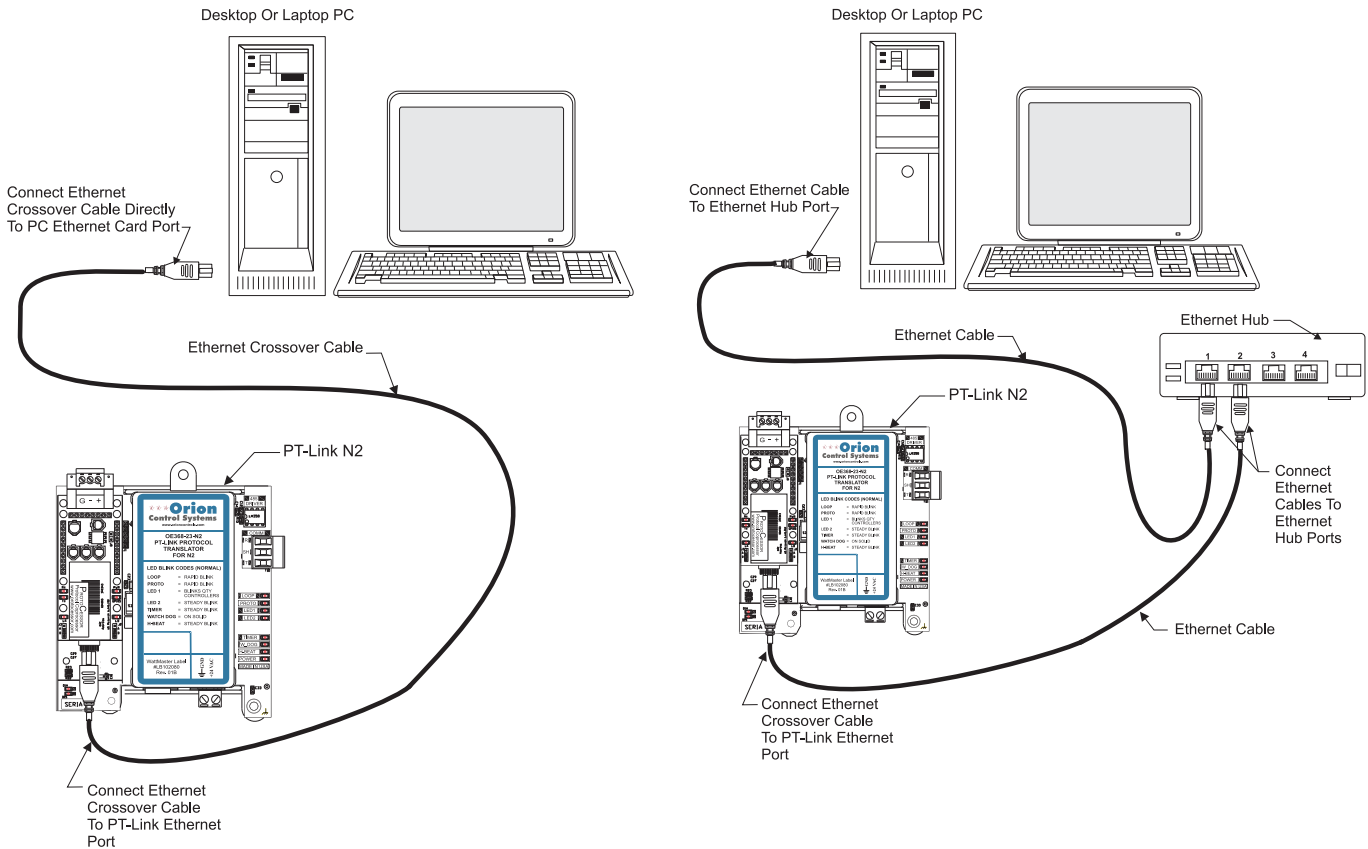

Figure 4: Connecting With Ethernet Cable & Hub

Figure 3: Connecting With Crossover Cable

Computer IP Address Set-up for Windows XP, Vista, and 7

In order for the PT-Link II to communicate properly, it is imperative to set the IP address of both the PT-Link II as well as the computer to be within the same netmask. You need to change the IP address on your computer. The following instructions will explain how to configure the IP address for Microsoft® Windows XP, Vista, and 7 operating systems.

Computer IP Address Set-up for Windows NT & XP

- 1.) Click <start>; then click <Control Panel>.
- 2.) Double-click on the **Network Connections** icon. The *Network Connections Window* will appear (**Figure 5**).

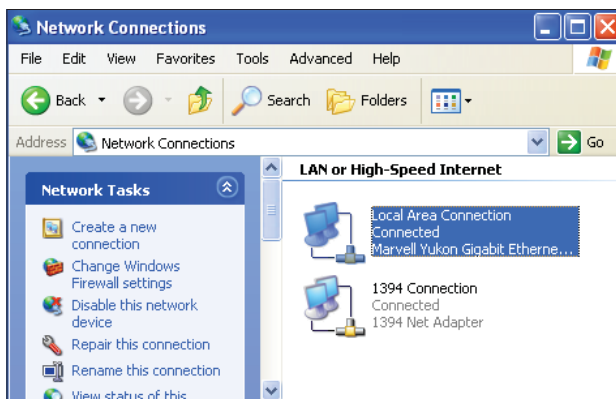

Figure 5: Network Connections Window

NOTE: If any wireless connections are listed, disable them by *right-clicking* the connection and *selecting* <Disable>.

- 3.) In the *Network Connections Window*, double-click the **Local Area Connections** entry. The *Local Area Connection Status Window* will appear (**Figure 6**).

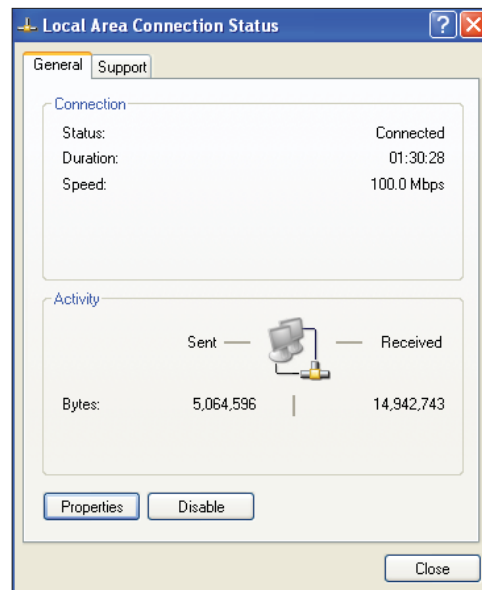

Figure 6: Local Area Connection Status Window

- 4.) As shown in **Figure 6**, click <Properties> in the lower left of the window. The *Local Area Connection Properties Window* will appear.

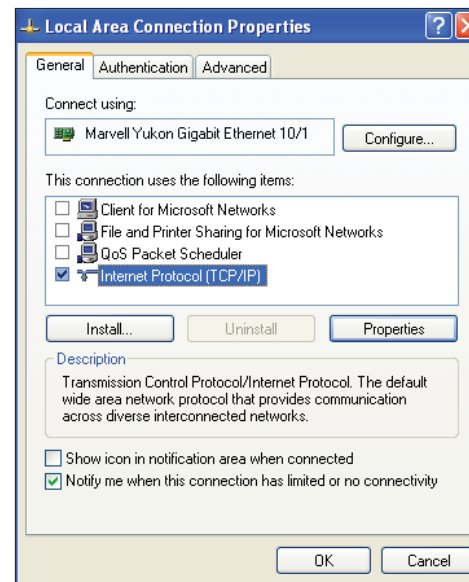

Figure 7: Local Area Connection Properties Window

- 5.) As shown in **Figure 7**, in the Connection Items list box, be sure the **Internet Protocol (TCP/IP)** is checked. *Select the Internet Protocol (TCP/IP) item to highlight it and then click* <Properties>. The *Internet Protocol Properties Window* will appear.

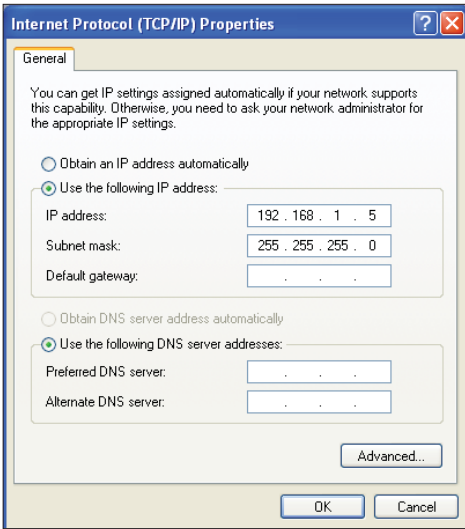

Figure 8: Internet Protocol Properties Window

- 6.) *Select* the radio button in front of **Use the following IP address (Figure 8)** and *write down* the current defaults so that you can re-enter them when you finish configuring the PT-Link II and then *type in* the following information:
 - a.) IP address 192.168.1.5
 - b.) Subnet mask 255.255.255.0
 - c.) Default Gateway is blank
- 7.) *Click* <OK> until all of the above network configuration windows are closed. You may have to *reboot* the computer before the new values are valid.

Computer IP Address Set-up for Windows Vista & 7

- 1.) *Click* <start>; then *click* <Control Panel>.
- 2.) *Click* on the **Network and Internet** icon.
- 3.) *Click* **Network and Sharing Center**.
- 4.) From the shaded box in the left side of the window, select **Manage Network Connections (Vista) or Change adapter settings (Windows 7)**.
- 5.) *Right-click* on the **Local Area Connection** icon and *select* <Properties> for the drop down window.
- 6.) *Choose* **Internet Protocol Version 4 (TCP/IPv4)** by highlighting it and then *click* <Properties>. The *Internet Protocol Properties Window* will appear (**Figure 8**).
- 7.) *Select* the radio button in front of **Use the following IP address (Figure 8)** and write down the current defaults so that you can re-enter them when you finish configuring the PT-Link II and then *type in* the following information:
 - a.) IP address 192.168.1.5
 - b.) Subnet mask 255.255.255.0
 - c.) Default Gateway is blank
- 9.) *Click* <OK> until all of the above network configuration windows are closed. You may have to *reboot* the computer before the new values are valid.

Connecting To The PT-Link

1.) In order to communicate and program the PT-Link II you will need to install RUINET software on your computer. If you do not have the software, it is available for downloading at www.orioncontrols.com/software-new.html under PT-Link II Software

WARNING: Make sure to load RUINET onto your hard drive and run the program from your hard drive. DO NOT under any circumstances run RUINET from your cd drive.

2.) If RUINET is in the desktop directory (if it isn't, locate its directory), double-click on RUINET, and the RUINET program should run. Initially, you might see the screen below (Figure 9). Type <1> for Specify IP Address and the message "Enter IP Address of the Field Server to Connect to" will appear on the screen.

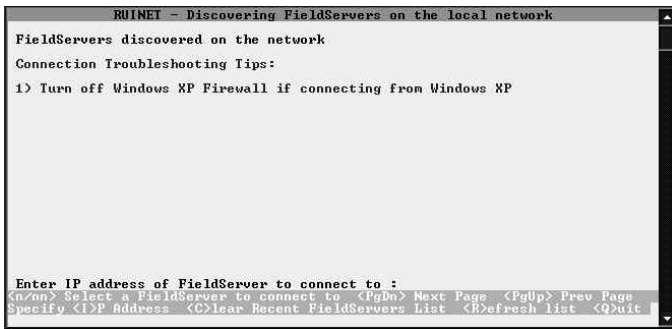

Figure 9: RUINET PT-Link II Specify IP Address

3.) Type the IP Address of <192.168.1.24> and press <Enter>.

4.) If you have only one PT-Link II connected to the network, then RUINET will automatically connect to that particular PT-Link; otherwise, a menu will appear to allow the selection of the desired PT-Link.

NOTE: If RUINET is unable to establish a connection, there are a few simple procedures you can perform to try to determine the problem. To verify your network cables, observe the green LED displayed directly above and to the right of the Ethernet port. This LED should be on if the 10 BaseT cable is good. Secondly, observe the red LED displayed directly above and to the left of the Ethernet port. This LED should be solid while RUINET is running. If the LEDs are lit as expected, and RUINET still does not receive replies, then the netmask is probably incorrect. If this does not help, then your Ethernet setup on your PC is possibly not compatible. Ensure that you have an Ethernet adapter installed in your software configuration and that it is configured to run the TCP/IP protocol. If you are still unable to connect, please contact WattMaster Controls.

5.) On subsequent connections, a list of PT-Links that have been recently connected may appear under the message "Recently connected to FieldServers". Select the required PT-Link II by typing the Number or Letter in the left hand column. (Figure 10).

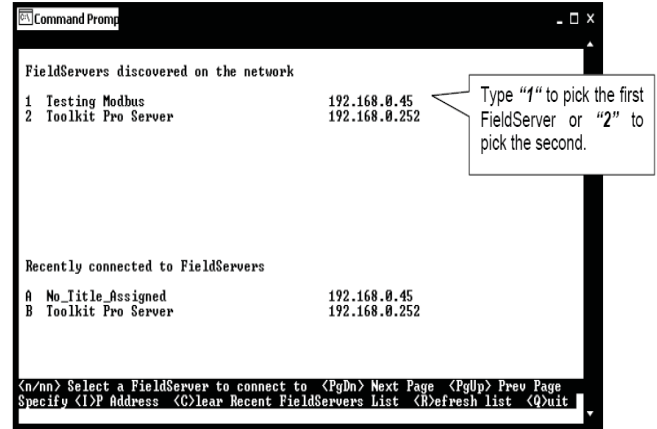

Figure 10: RUINET PT-Link II Selection Menu

6.) Once connected, you will see the *RUINET Main Menu* (Figure 11). Unless you need to make changes to the config.csv file (steps 7 through 15), you are now ready to send and receive files to and from the PT-Link.

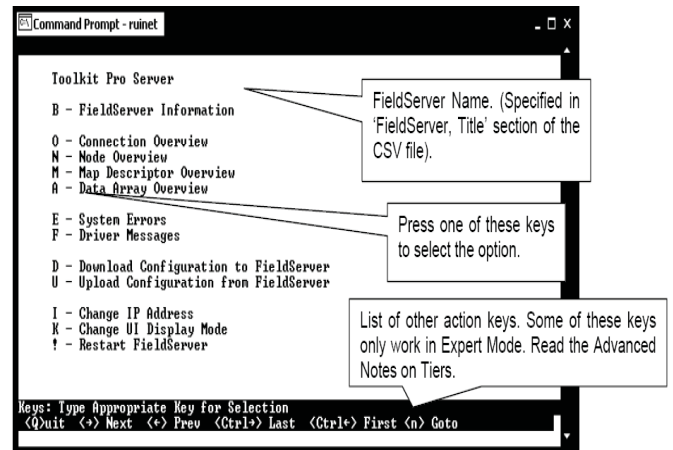

Figure 11: RUINET PT-Link II Main Menu

Changing the Config.csv File

7.) Type the letter <U> to upload the Config file (**Figure 12**), then type <U> again (**Figure 13**) for Upload.

8.) You will get confirmation that the upload is complete. Type <N> to open the file in Notepad.

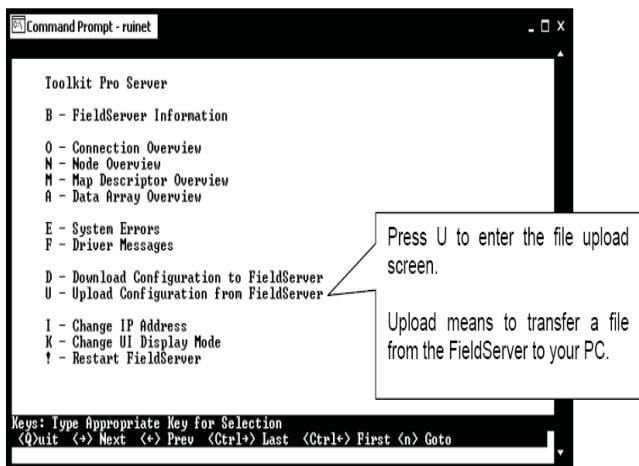

Figure 12: RUINET PT-Link II Main Menu - Upload

WARNING: Only edit the config.csv file using Notepad. **DO NOT** use Excel. Using Excel to edit the config.csv file will corrupt its contents!

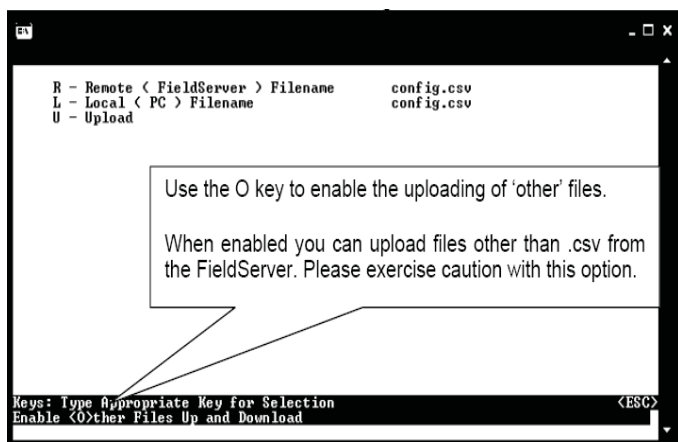

Figure 13: RUINET PT-Link II Upload

Changing the Config.csv File

9.) You can change the Node_ID under ‘Client Side Nodes’ which is the N2 Device Instance Number (Figure 14). The default is 1. You can obtain this information from your BAS Integrator. To see how the N2 Address is calculated, see page 13.

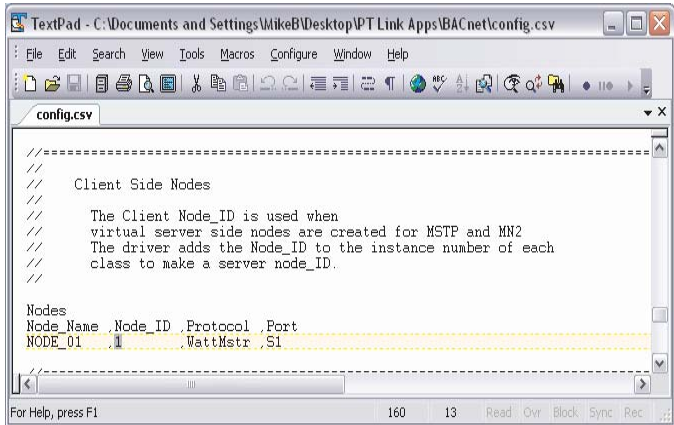

Figure 14: Changing the Node ID in Notepad

10.) Once the changes are made to the text file, click <File> in the upper left and then click <Save>. Now close the file and return to the RUINET Main Menu.

11.) From the RUINET Main Menu, type <D> to Download the new config.csv file to the FieldServer (Figure 15).

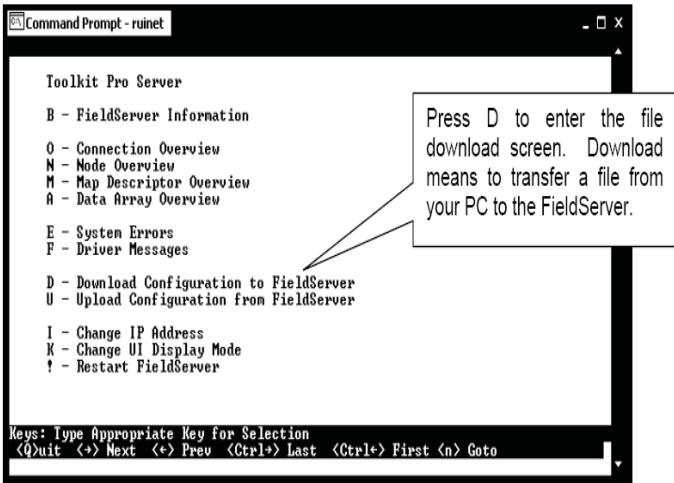

Figure 15: Download new Config.csv file

12.) At the next screen, (Figure 16), type <D> again.

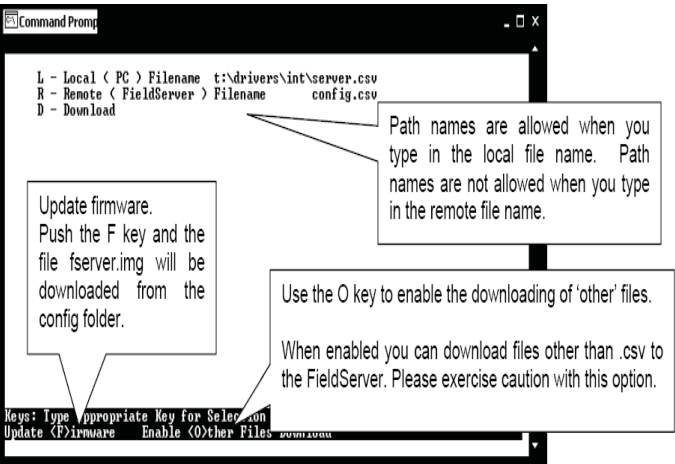

Figure 16: Download new Config.csv file

NOTE: The utility will indicate when downloading is complete. **DO NOT** reset the PT-Link II until this message is displayed, as this will corrupt the PT-Link.

NOTE: The Remote Filename option must always be named “config.csv” for configurations; otherwise, it will be ignored by the PT-Link.

WARNING! Set the PT-Link II to the “External Vendor Device” in order to see it correctly in the N2 Front End.

13.) Once the download is complete, restart the PT-Link II by cycling power or press <Esc> to get back to the RUINET Main Menu and then type <!> option to save the new configuration file and restart RUINET. It is possible to do multiple downloads to the PT-Link II before resetting it. There will be a start-up period where you will be unable to connect to the PT Link.

14.) From the RUINET Main Menu, type <A> for the Data Array Overview. The Data Array Overview Screen will display (Figure 17).

Verifying PT-Link II Communications

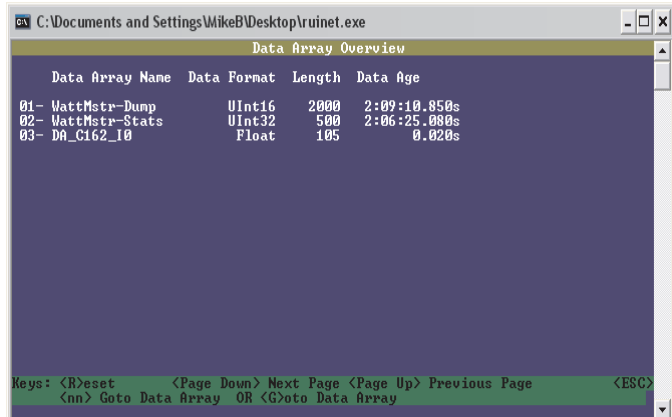

Figure 17: Data Array Overview Screen

15.) This screen (**Figure 17**) will verify communication to the HVAC units. Lines 1 & 2 should always be present. After a start-up period of approximately 4 minutes, you will see 1 additional line for each HVAC unit. This screen represents the PT Link communicating with 1 HVAC unit.

16.) Once these steps have been completed and you have verified that the reconfigured PT Link has established communication to the HVAC unit(s), it can now be added to the BAS network.

Addressing WattMaster Devices in an N2® Network.

Each PT-Link II N2® has the ability to generate virtual devices for all of the WattMaster controls connected to it. Each virtual device operates as an independent device and has all of the parameters pertinent to its kind of control—VCM, VAV/CAV, or MUA II. The address of the virtual device is calculated using the following formula:

Virtual Device Address = [unit address (address set using DIP switches on WattMaster controls) + Node_ID (value in the PT-Link II N2® configuration file) - 1]. Example:

- 1.) The PT-Link II N2® has a Node_ID equal to five.
- 2.) Two WattMaster controls connected and addressed to one and four.
- 3.) The N2® client will see two devices—one will be device five and the other will be device eight.

Virtual N2 Device Address Example Calculation			
AHU Controller Address		1	4
Node_ID	+	5	5
	-	-1	-1
Virtual N2 Device Address	=	5	8

NOTE: To simplify the calculation, we recommend that the WattMaster controls be addressed in sequential order from one to the last control without any unused address(es) in between.

Troubleshooting the PT-Link II Controller

PT-Link II Board LEDs

The PT-Link II N2® is equipped with LEDs that can be used for troubleshooting. There are eight LEDs on the PT-Link II board. See **Figure 19** for the locations of the LEDs on the PT-Link II board. The LED descriptions and functions are listed in the following paragraphs.

POWER LED

When the PT-Link II N2® is powered up, the “**POWER**” LED should light up and stay on continuously. If it does not light up, check to be sure that you have 24 VAC connected to the board, that the wiring connections are tight, and that they are wired for correct polarity. The 24 VAC power must be connected so that all ground wires remain common. If after making all these checks the “**POWER**” LED still does not light up, please contact WattMaster Controls Technical Support at our Toll Free number—866-918-1100—for assistance.

LOOP LED

When power is applied to the PT-Link II N2®, the “**LOOP**” LED will also light up. The LED should flicker rapidly, indicating that the PT-Link II is trying to communicate with the controllers on the loop. A “**flicker**” is defined as a brief moment when the LED turns off and back on. If the “**LOOP**” LED does not operate as indicated above, first power down the unit and then reapply power. If this does not work, please contact WattMaster Controls Technical Support at our Toll Free number—866-918-1100—for assistance.

LED 1

When power is first applied, “**LED 1**” will be off temporarily and then will blink one time for each controller it is communicating with. For example, if you have 4 controllers on the loop connected to the PT-Link, “**LED 1**” will blink 4 times. If the amount of blinks does not match the number of controllers connected to the loop, it indicates there is a communications problem. The best way to find out which board is not communicating is to go to each controller and look at its “**COMM**” LED. The “**COMM**” LED should be solid and will flicker occasionally indicating communication with the PT-Link II N2®. If the “**COMM**” LED does not flicker, there is no communication with that controller.

LED 2

When power is first applied, “**LED 2**” will be off temporarily and then will blink slowly indicating that the PT-Link II baseboard is communicating with the Protoessor Module. If “**LED 2**” does not blink, check that the Protoessor Module is installed correctly on the PT-Link II baseboard and that the “**PWR**” LED is lit up on the Protoessor Module.

PROTO LED

When the PT-Link II is first powered up, the “**PROTO**” LED should light up and stay on continuously. If the LED doesn’t light up, check that the Protoessor is installed correctly and firmly connected to the Base Board. The “**PWR**” LED should also be lit on the Protoessor Module.

TIMER LED

The “**TIMER**” is used for troubleshooting by WattMaster Controls Technical Support. The “**TIMER**” LED should always have a steady blink.

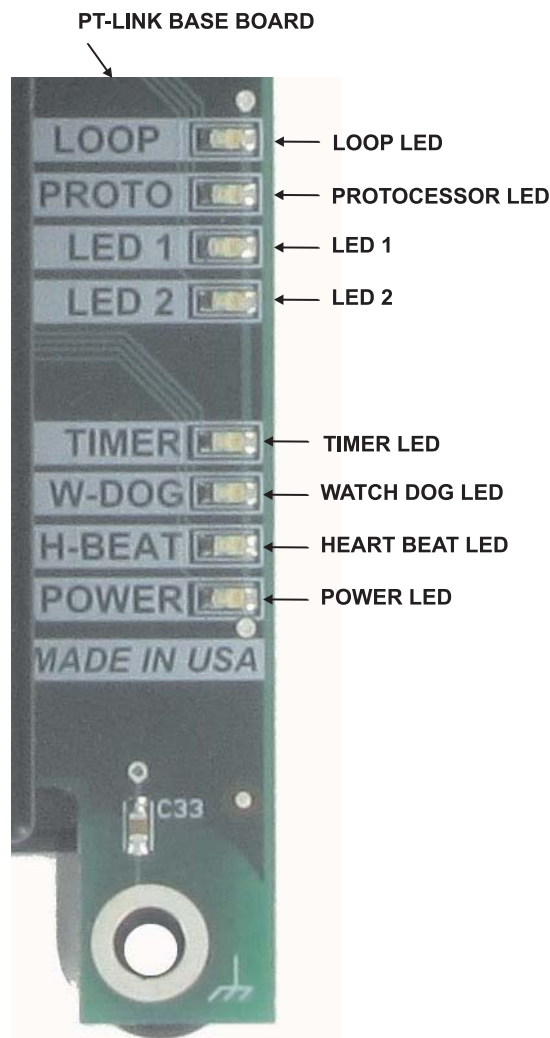

Figure 19: PT-Link II N2® LED Locations

WATCH DOG LED

The “**W-DOG**” LED is used for troubleshooting by WattMaster Controls Technical Support. The “**W-DOG**” LED should always be on solid.

HEARTBEAT LED

The “**H-BEAT**” LED blinks to show there is communication between the controllers and the PT-Link. If the LED doesn’t light up, and all other checks have been made, please contact WattMaster Controls Technical Support at our Toll Free number—866-918-1100—for assistance.

Troubleshooting the PT-Link II Controller

Processor Module LEDs

PWR LED

When the PT-Link II is first powered up, the “**PWR**” LED should light up and stay on continuously. **See Figure 20**. If the LED doesn’t light up, check that the ProtoCessor is installed correctly and firmly connected to the Base Board.

GPI05 LED

The “**GPI05**” LED will light up when the Base Board and the ProtoCessor Module have established communications. **See Figure 20**. This can take up to 3 minutes depending on the number of units connected to the PT-Link. If it fails to light up after 3 minutes, check that the ProtoCessor is installed correctly and firmly to the Base Board.

LB LED

Once the unit is powered up, the “**LB**” LED must be blinking constantly. **See Figure 20**. If this LED is constantly on or off, the Module is not working properly and needs to be replaced.

LA LED

Once the unit is powered up, the “**LA**” LED must be blinking constantly. **See Figure 20**. If this LED is constantly on or off, the Module is not working properly and needs to be replaced.

TX & RX LEDs

The “**TX**” and “**RX**” LEDs work together to indicate that communication is being established with the desired protocol network. If both LEDs are blinking, then communication is working properly. **See Figure 20**. If not, check the protocol network wiring and the baud rate in the configuration file.

D14 & D15 LEDs

The “**D14**” and “**D15**” LEDs work together to indicate that communication is being transmitted and received from the USB Port when performing an update to the PT-Link II software.

If all of these tests are made and the controller still doesn’t operate, please contact WattMaster Controls Technical Support at our Toll Free number—866-918-1100—for assistance.

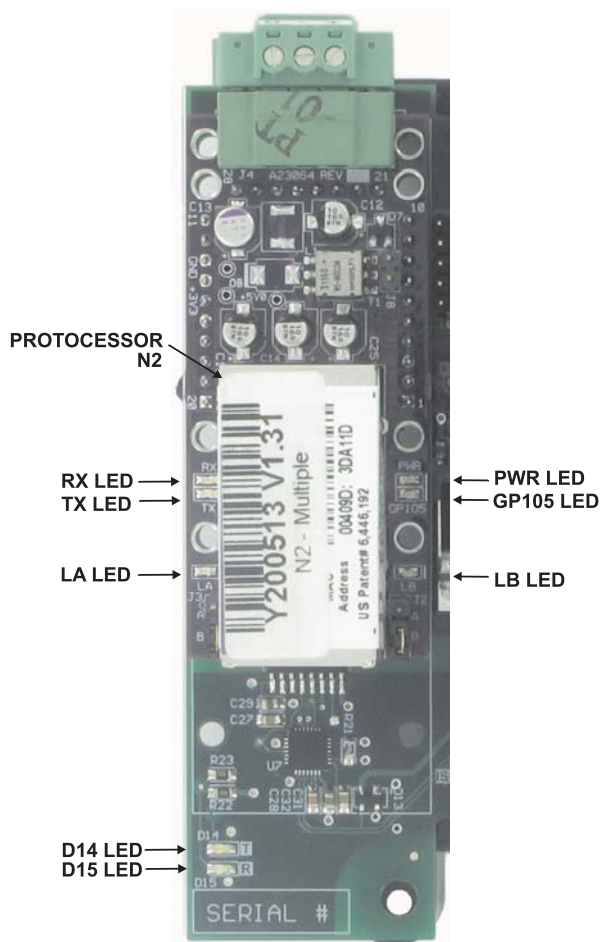

Figure 20: PT-Link II N2® LED Locations

Troubleshooting the PT-Link II Controller

Using RUINET

Before continuing with the troubleshooting, make sure the PT-Link II is connected correctly and the RUINET software is installed, running, and functioning correctly.

Verifying Proper Communications

From the *RUINET Main Screen*, press <O> to go the *Connection Overview Screen*. This screen supplies information on communication between the PT-Link II and remote devices. A number of aspect screens are available, and some of the aspect screens have more than one page. Use the space bar to toggle between aspects and use the <PgUp> and <PgDn> keys to toggle between pages of the same aspect. The *Connection Overview and Settings Aspect Screen* is shown in **Figure 21**.

The main purpose in this screen is to verify that messages and characters are being transmitted and received. In addition, it shows the number of communication errors. If the PT-Link II connection "03" is the protocol connection, verify that is communicating appropriately. If it is not, check that the PT-Link II LEDs are working properly, the unit is wired correctly, and the PT-Link II is configured correctly (Baud Rate, Unit Address & MAC Address). If the number of errors is constantly increasing, move to the *Error Screen* by pressing the <Space Bar> 3 times to find out the cause of the errors. Use the <PgUp> and <PgDn> keys to toggle between pages of the *Error Screen*.

Verifying Proper Values

To verify that the correct values for each unit are being communicated to the PT-Link, move to the *Data Array Overview Screen*. To get to the screen, press <A> from the *RUINET Main Menu*. See **Figure 22** for screen details.

In the *Data Array Overview Screen* (**Figure 22**) you will be able to see the data arrays of all the units connected to the PT-Link II denoted by an array name "DA_XXX_IY"—Y being the address of the unit minus one. The Address of the unit is determined by a set of dip switches. To view the values being communicated from a specific unit, move to the *Data Array Detail Screen* (**Figure 23**) of the unit by entering the number under which it is listed. For example, for the unit listed in the third position, enter <O3>.

To understand what each value means, look at the Data Array Tables for the desired unit type, VCM-X, SA, or VCM. You can change the writable values from this screen by using the modify command. To use the modify command, press <M> from the *Data Array Detail Screen* and then enter the Offset you want to change followed by a space and the new value.

Example: To change the Cooling Supply Setpoint to 60 in the VCM, press <M>, enter <58 60>, and then press <Enter>. This could be useful to prove that the unit can take and keep the setpoints properly.

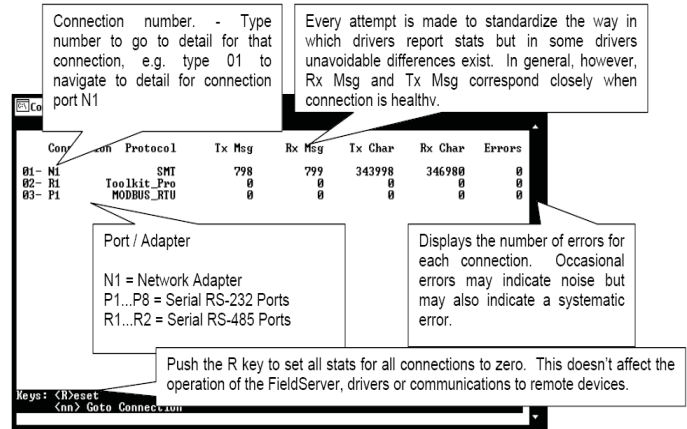

Figure 21: Connection Overview Screen

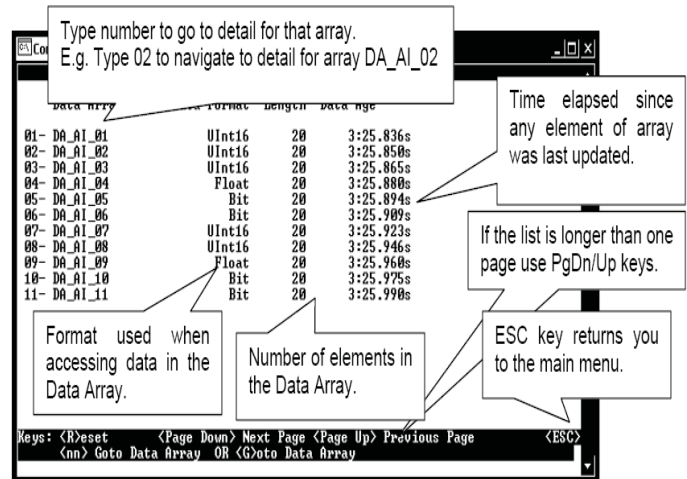

Figure 22: Data Array Overview Screen

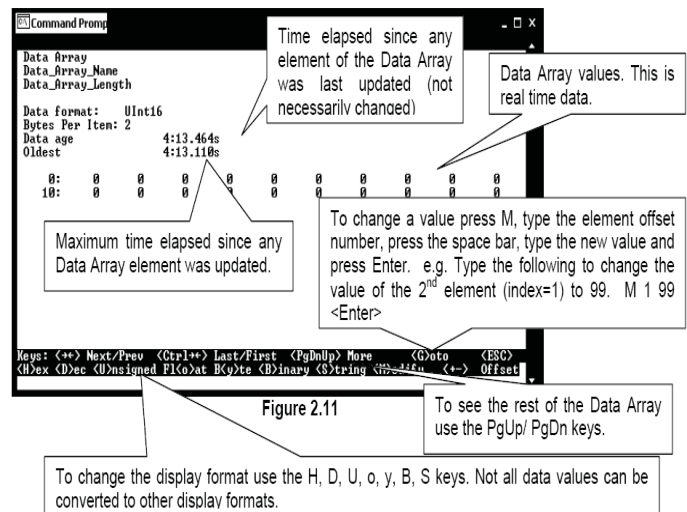

Figure 23: Data Array Detail Screen

Programming the PT-Link II with BootLoader

The PT-Link II is equipped with the ability to update its software with the use of a computer. You will need the following before you begin:

- PT-Link II in need of an update (powered up, no other connections necessary)
- Computer running Microsoft Windows™ operating system
- Prism II software from www.orioncontrols.com/software-new.html
- Latest version of PT-Link II software (e-mailed from our tech support staff or downloaded from any of our websites) and software sheet
- USB Driver Setup.exe file located on the PT-Link II CD or downloaded from any of our websites
- USB cable

Follow these simple steps to update the PT-Link II:

1.) Turn on your computer and download the latest Prism II software from www.orioncontrols.com/software-new.html.

2.) Either download the PT-Link II update file from <http://techsupport.wattmaster.com> or save the file to your computer from the e-mail you received from Tech Support. Record the path and name of the file for later use. Also, print the software sheet provided for future reference.

3.) Run the USB Driver Setup.exe file located on the PT-Link II CD or downloaded from any of our websites so that Prism can communicate to the PT Link II. Unzip the file to the directory where you saved your PT-Link II software.

4.) Plug the USB cable into the computer's and PT-Link II's USB ports.

5.) A message will pop-up from the lower menu bar of Windows that reads, "Found New Hardware." Click on this message and follow the instructions that appear to install the USB drivers.

6.) Open Prism II and Login with the password "Flash." If successful, "Level 4 Access" will appear at the lower right of the Prism program.

7.) Click on the <Job-Site> icon. The *Job-Sites Window* will appear. In the *Type of CommLink Dialog Box*, select "Hi Speed CommLink."

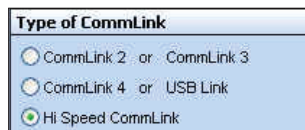

8.) In the *Job-Sites Window*, from the Serial Port drop down list, select the correct COM port. If you don't know the COM port number or if the number is 10 or higher, follow the directions on pages 19-20.

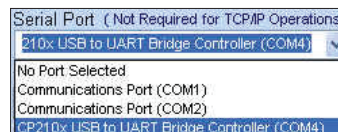

9.) From Prism II's Communications tab, select "Flash Selected Controller."



10.) The *Flash Controller Window* will appear.

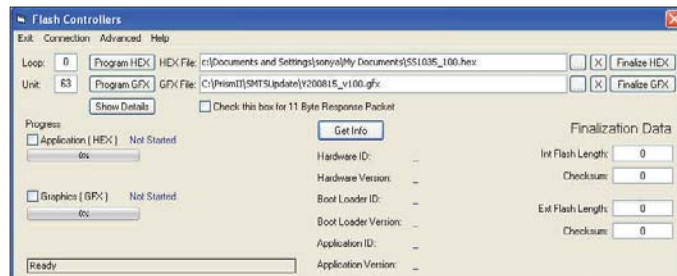

11.) From the *Flash Controller Window's* Connection tab, select "Direct". Keep the *Flash Controller Window* open.



12.) Cycle power to the PT-Link II and within 5 seconds, click the <Get Info> button in the *Flash Controller Window*. The PT-Link II information will now appear in the window under the <Get Info> button.



Updating the PT-Link II Controller

13.) The Application ID should be SS1035 and the Application Version should match the software version you will be updating to.

14.) In the HEX File field, enter the path and name of the HEX file you downloaded and/or copied to your hard drive. Use the Browse button (...) to the right of the field if you need help in locating the file.

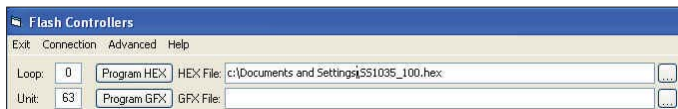

15.) Now, cycle power to the PT-Link II once again and within 5 seconds click on the <Program HEX> button (shown above). If successful, you should see the Progress Application HEX bar showing the progress percentage.

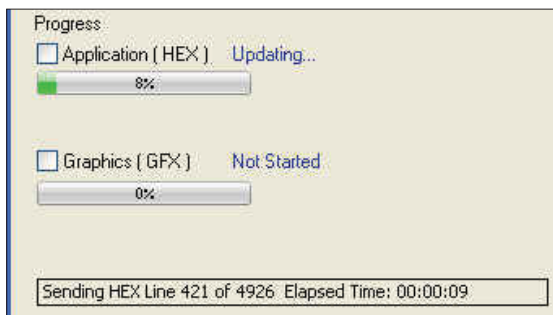

16.) When the bar shows 100% completed, verify the PT-Link II's software is running by observing the Timer LED blinking.

17.) Verify the PT-Link II's Application Version by once again cycling power to the PT-Link II and within 5 seconds clicking the <Get Info> button.

18.) Verify all fields are correct in the information below the <Get Info> button and under "Finalization Data." The "Int Flash Length" and "Checksum" values should match the values provided with the software sheet.

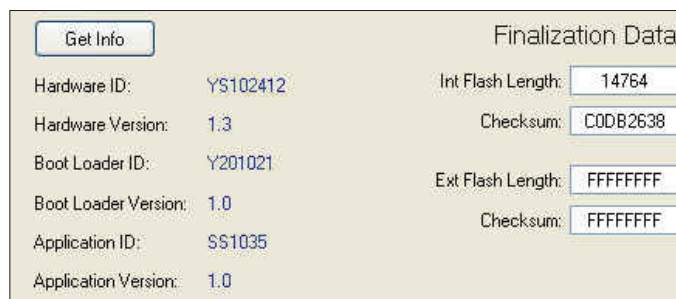

Finding What COM Port Number the CommLink IV is Using

1. *Left-click* on <Start>, located on the bottom left of the Windows Tool Bar.



2. *Select* <Control Panel>.

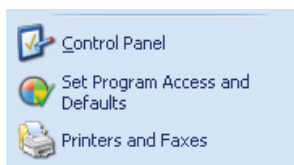

3. *Double-click* the System icon.



System

4. *Click* the <Hardware> tab.

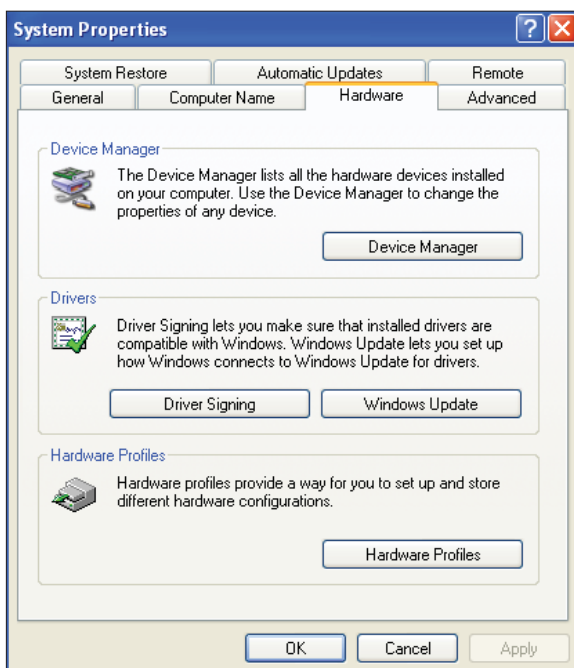

5. *Click* the <Device Manager> button.

6. *Click* on the plus sign next to Ports to see all of the common ports.

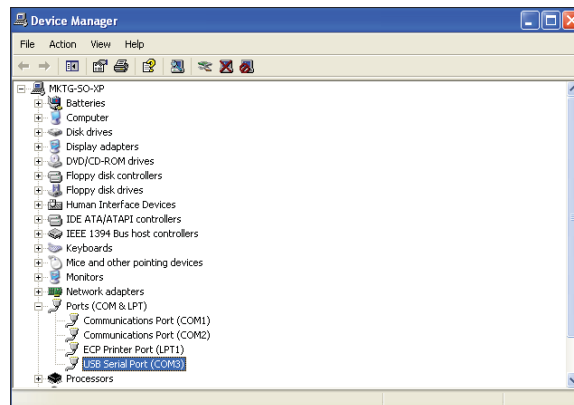

7. *Locate* the USB Serial Port (COM#). The COM# in parentheses is the port it is located on. *Write* this COM port number down. You will need to know this when setting up the Prism software.
8. If the COM port number is 10 or greater, go to “Changing the USB COM Port Number” on page 20.

Updating the PT-Link II Controller

Changing the USB COM Port Number

When the CommLink is first plugged in, it will be assigned a COM port number to be used for communicating with the Prism software. If the port number is 10 or greater, it needs to be changed to a value less than 10 to be recognized by Prism.

1. Click <Start>, click <Control Panel>, click <System>, click the <Hardware> tab, and then click <Device Manager> to get to the *Device Manager Window*.
2. Click on the plus sign next to Ports to see all of the COM ports.

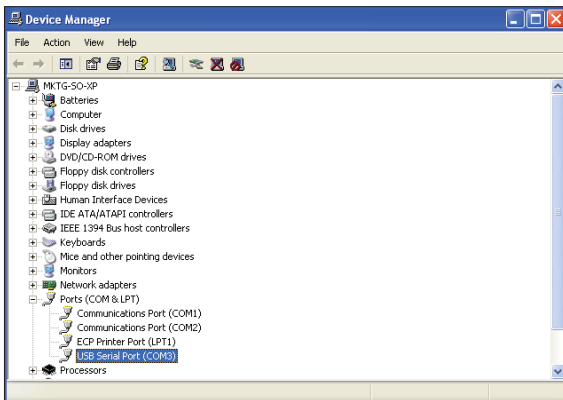

3. Right-click on “USB Serial Port (COM#)” and select <Properties>. In the *Properties Window*, select the <Port Settings> tab.

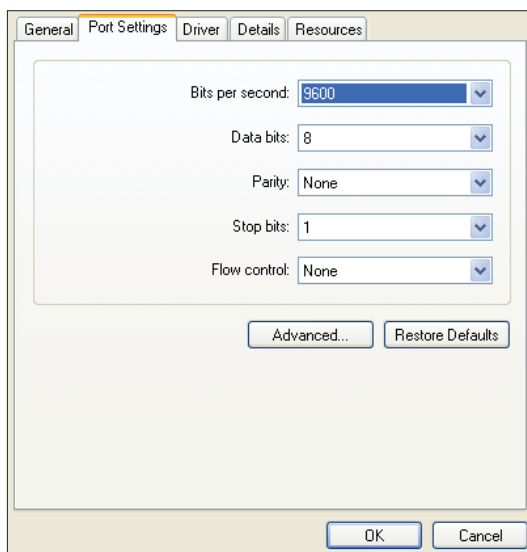

4. To assign a port number less than 10, click on <Advanced>. The *Advanced Settings Window* will appear.

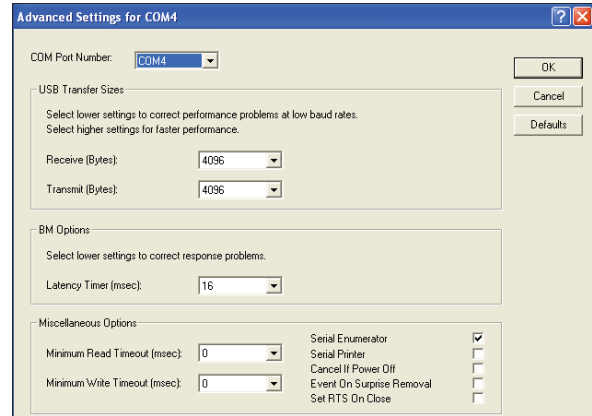

5. In the COM Port Number drop box, select which COM port you wish to use. Make sure you select a COM port number that is not currently in use (you can see the ports in use in the *Device Manager Window*). Select a port that is less than 10.

NOTE: Windows® will assign a port number to every device that has ever been installed on your computer. So if there are no available ports below 10, choose a port number less than 10 for a device listed that you know you are not currently using.

6. Once you select the correct COM port number, click <OK> and close any windows opened in the process of changing the port number. Make note of this number because you will need it for your Prism setup.

VCM-X Modular & VCM-X WSHP (Tulsa) Data Arrays

VCM-X Modular Data Array For Field Server								
Offset	0	1	2	3	4	5	6	7
0	AppVer	ClSt	HtSt	OaWtbl	TpDmnd	SpCtp	SaTp	RaTp
8	OaTp	DuctPr	OaRh	UnitMode	CtrlSts	ClEnbl	HtEnbl	EcoEnbl
16	FanDly	PofCfg	CO2Cfg	MdHt2Ins	Rt2Ins	OnRlys	ExRlys12	ExRlys34
24	EcoPos	VfdBwPos	VfdExPos	AlrmSts	AlrmGrp1	AlrmGrp2	AlrmGrp3	SaTpAlm
32	OaTpAlm	SpCtpAlm	MchClAlm	MchHtAlm	PofAlm	DrtFAlm	SmokeAlm	LoSaAlm
40	HiSaAlm	CtrlTpCF	CtrlTpHF	CtrlTp	InRh	InRhStM	DptStM	MdClPos
48	MdHtPos	MdHt2Pos	Rt2Pos	OcpClSt	OcpHtSt	UnClOst	UnHtOst	WtblSt
56	SaClSt	SaHtSt	WmupSt	SpCtpOst	SaTpOst	RaTpOst	OaTpOst	CoilTpSt
64	DptSt	InRhSt	DuctPrSt	RfPrSt	SchdFrc	OnRly1	OnRly2	OnRly3
72	OnRly4	OnRly5	ExRly1	ExRly2	ExRly3	ExRly4	ExRly5	ExRly6
80	ExRly7	ExRly8	ExRly9	ExRly10	ExRly11	ExRly12	ExRly13	ExRly14
88	ExRly15	ExRly16	CO2St	MinEcoSt	CO2Level	ByPasDmp	RaDmp	RfPr
96	OaDwpt	CoilTp	SaTpStM	PreHtSp	OaCFM	EtCFM	SaCFM	OACfmSt
104	OACfmRs	OACfmStM	MdCmp2	HdPr1	HdPr2	CdFan1	CdFan2	RmVFDPos

Table 2: VCM-X Modular Data Array For Field Server

VCM-X WSHP (Tulsa) Data Array For Field Server								
Offset	0	1	2	3	4	5	6	7
0	AppVer	ClSt	HtSt	OaWtbl	TpDmnd	SpCtp	SaTp	RaTp
8	OaTp	DuctPr	OaRh	UnitMode	CtrlSts	ClEnbl	HtEnbl	EcoEnbl
16	FanDly	PofCfg	CO2Cfg	MdHt2Ins	Rt2Ins	OnRlys	ExRlys12	ExRlys34
24	EcoPos	VfdBwPos	VfdExPos	AlrmSts	AlrmGrp1	AlrmGrp2	AlrmGrp3	SaTpAlm
32	OaTpAlm	SpCtpAlm	MchClAlm	MchHtAlm	PofAlm	DrtFAlm	SmokeAlm	LoSaAlm
40	HiSaAlm	CtrlTpCF	CtrlTpHF	CtrlTp	InRh	InRhStM	DptStM	MdClPos
48	MdHtPos	MdHt2Pos	Rt2Pos	OcpClSt	OcpHtSt	UnClOst	UnHtOst	WtblSt
56	SaClSt	SaHtSt	WmupSt	SpCtpOst	SaTpOst	RaTpOst	OaTpOst	CoilTpSt
64	DptSt	InRhSt	DuctPrSt	RfPrSt	SchdFrc	OnRly1	OnRly2	OnRly3
72	OnRly4	OnRly5	ExRly1	ExRly2	ExRly3	ExRly4	ExRly5	ExRly6
80	ExRly7	ExRly8	ExRly9	ExRly10	ExRly11	ExRly12	ExRly13	ExRly14
88	ExRly15	ExRly16	CO2St	MinEcoSt	CO2Level	ByPasDmp	RaDmp	RfPr
96	OaDwpt	CoilTp	SaTpStM	PreHtSp	OaCFM	EtCFM	SaCFM	OACfmSt
104	OACfmRs	OACfmStM	MdCmp2	HdPr1	HdPr2	CdFan1	CdFan2	WaterTpA
112	WaterTpB	A1LSPAlm	A1LktAlm	A2LSPAlm	A2LktAlm	B1LSPAlm	B1LktAlm	B2LSPAlm
120	B2LktAlm	LWT1Alm	LWT2Alm	POWF1Alm	POWF2Alm	ComMAlm	RmVFDPos	–

Table 3: VCM-X WSHP (Tulsa) Data Array For Field Server

VCM-X WSHP (Coil) & VCM-X Data Arrays

VCM-X WSHP (Coil) Data Array For Field Server								
Offset	0	1	2	3	4	5	6	7
0	AppVer	ClSt	HtSt	OaWtbl	TpDmnd	SpCtp	SaTp	RaTp
8	OaTp	DuctPr	OaRh	UnitMode	CtrlSts	ClEnbl	HtEnbl	EcoEnbl
16	FanDly	PofCfg	CO2Cfg	MdHt2Ins	Rt2Ins	OnRlys	ExRlys12	ExRlys34
24	EcoPos	VfdBwPos	VfdExPos	AlrmSts	AlrmGrp1	AlrmGrp2	AlrmGrp3	SaTpAlm
32	OaTpAlm	SpCtpAlm	MchClAlm	MchHtAlm	PofAlm	DrtFAlm	SmokeAlm	LoSaAlm
40	HiSaAlm	CtrlTpCF	CtrlTpHF	CtrlTp	InRh	InRhStM	DptStM	MdClPos
48	MdHtPos	MdHt2Pos	Rt2Pos	OcpClSt	OcpHtSt	UnClOst	UnHtOst	WtblSt
56	SaClSt	SaHtSt	WmupSt	SpCtpOst	SaTpOst	RaTpOst	OaTpOst	CoilTpSt
64	DptSt	InRhSt	DuctPrSt	RfPrSt	SchdFrc	OnRly1	OnRly2	OnRly3
72	OnRly4	OnRly5	ExRly1	ExRly2	ExRly3	ExRly4	ExRly5	ExRly6
80	ExRly7	ExRly8	ExRly9	ExRly10	ExRly11	ExRly12	ExRly13	ExRly14
88	ExRly15	ExRly16	CO2St	MinEcoSt	CO2Level	ByPasDmp	RaDmp	RfPr
96	OaDwpt	CoilTp	SaTpStM	PreHtSp	OaCFM	EtCFM	SaCFM	OACfmSt
104	OACfmRs	OACfmStM	MdCmp2	HdPr1	HdPr2	CdFan1	CdFan2	WaterTpA
112	AILSPAlm	AILktAlm	B1LSPAlm	B1LktAlm	LWT1Alm	POWF1Alm	ComMAlm	RmVFDPos

Table 4: VCM-X WSHP (Coil) Data Array For Field Server

VCM-X Data Array For Field Server								
Offset	0	1	2	3	4	5	6	7
0	AppVer	ClSt	HtSt	OaWtbl	TpDmnd	SpCtp	SaTp	RaTp
8	OaTp	DuctPr	OaRh	UnitMode	CtrlSts	ClEnbl	HtEnbl	EcoEnbl
16	FanDly	PofCfg	CO2Cfg	MdHt2Ins	Rt2Ins	OnRlys	ExRlys12	ExRlys34
24	EcoPos	VfdBwPos	VfdExPos	AlrmSts	AlrmGrp1	AlrmGrp2	AlrmGrp3	SaTpAlm
32	OaTpAlm	SpCtpAlm	MchClAlm	MchHtAlm	PofAlm	DrtFAlm	SmokeAlm	LoSaAlm
40	HiSaAlm	CtrlTpCF	CtrlTpHF	CtrlTp	InRh	InRhStM	DptStM	MdClPos
48	MdHtPos	MdHt2Pos	Rt2Pos	OcpClSt	OcpHtSt	UnClOst	UnHtOst	WtblSt
56	SaClSt	SaHtSt	WmupSt	SpCtpOst	SaTpOst	RaTpOst	OaTpOst	CoilTpSt
64	DptSt	InRhSt	DuctPrSt	RfPrSt	SchdFrc	OnRly1	OnRly2	OnRly3
72	OnRly4	OnRly5	ExRly1	ExRly2	ExRly3	ExRly4	ExRly5	ExRly6
80	ExRly7	ExRly8	ExRly9	ExRly10	ExRly11	ExRly12	ExRly13	ExRly14
88	ExRly15	ExRly16	CO2St	MinEcoSt	CO2Level	ByPasDmp	RaDmp	RfPr
96	OaDwpt	CoilTp	SaTpStM	PreHtSp	OaCFM	EtCFM	SaCFM	OACfmSt
104	OACfmRs	OACfmStM	-	-	-	-	-	-

Table 5: VCM-X Data Array For Field Server

SA Controller Data Array For Field Server								
Offset	0	1	2	3	4	5	6	7
0	AppVer	CISt	HtSt	TpDmnd	SpCtp	SaTp	DuctPr	UnitMode
8	CtrlSts	CIEnbl	HtEnbl	EcoEnbl	FanDly	MdHt2Ins	Rt2Ins	EcoPos
16	VfdBwPos	SaTpAlm	SpCtpAlm	MchCIAlm	MchHtAlm	PofAlm	DrtFAlm	LoSaAlm
24	HiSaAlm	CtrlTpCF	CtrlTpHF	CtrlTp	InRh	InRhStM	DptStM	MdCIPos
32	MdHtPos	MdHt2Pos	Rt2Pos	OcpCISt	OcpHtSt	UnCIOst	UnHtOst	SaCISt
40	SaHtSt	WmupSt	SpCtpOst	SaTpOst	CoilTpSt	DptSt	InRhSt	DuctPrSt
48	SchdFrc	OnRly1	OnRly2	OnRly3	OnRly4	OnRly5	ExRly1	ExRly2
56	ExRly3	ExRly4	ExRly5	ExRly6	ExRly7	ExRly8	ExRly9	ExRly10
64	ExRly11	ExRly12	ExRly13	ExRly14	ExRly15	ExRly16	CoilTp	SaTpStM
72	PreHtSp	EaTp	EwTp	EaRH	HdPr1	HdPr2	CoilTp2	EaDpt
80	WSEByp	WSEByp2	MdCmp2	CoilTpSt	CdPos1	CdPos2	EaTpAlm	EmerAlm
88	PoWFAlm	DrnAlm	EaTpOst	EwTpOst	-	-	-	-

Table 6: SA Controller Data Array For Field Server

VCM Data Array For Field Server								
Offset	0	1	2	3	4	5	6	7
0	AppVer	CISt	HtSt	OaWtbl	TpDmnd	SpCtp	SaTp	RaTp
8	OaTp	DuctPr	OaRh	UnitMode	CtrlSts	ClDmnd	HtDmnd	DehmDmnd
16	CIEnbl	HtEnbl	EcoEnbl	FanDly	WmupDmnd	PofCfg	CO2Cfg	MdHt2Ins
24	Rt2Ins	OnRlys	ExRlys12	ExRlys34	EcoPos	VfdBwPos	VfdExPos	AlrmSts
32	AlrmGrp1	AlrmGrp2	AlrmGrp3	SaTpAlm	OaTpAlm	SpCtpAlm	MchCIAlm	MchHtAlm
40	PofAlm	DrtFAlm	SmokeAlm	LoSaAlm	HiSaAlm	CtrlTpCF	CtrlTpHF	CtrlTp
48	InRh	InRhStM	DptStM	MdCIPos	MdHtPos	MdHt2Pos	Rt2Pos	OcpCISt
56	OcpHtSt	UnCIOst	UnHtOst	WtblSt	SaCISt	SaHtSt	WmupSt	SpCtpOst
64	SaTpOst	RaTpOst	OaTpOst	CoilTpSt	DptSt	InRhSt	DuctPrSt	RfPrSt
72	SchdFrc	OnRly1	OnRly2	OnRly3	OnRly4	OnRly5	ExRly1	ExRly2
80	ExRly3	ExRly4	ExRly5	ExRly6	ExRly7	ExRly8	ExRly9	ExRly10
88	ExRly11	ExRly12	ExRly13	ExRly14	ExRly15	ExRly16	CO2St	MinEcoSt
96	CO2Level	ByPasDmp	RaDmp	RfPr	OaDwpt	CoilTp	SaTpStM	PreHtSp

Table 7: VCM Data Array For Field Server

Appendix A

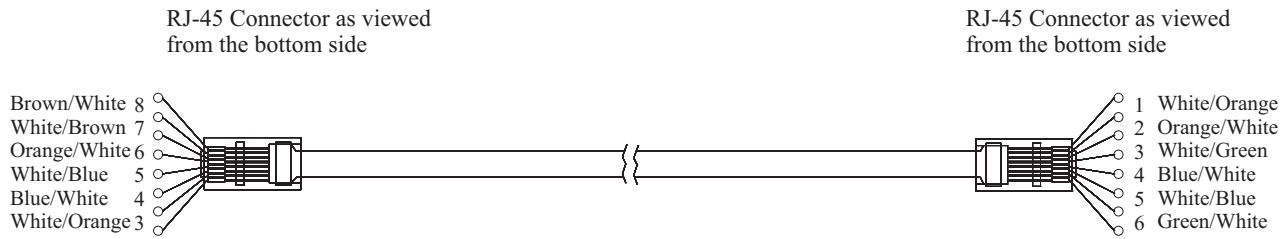

Use the standard EIA/TIA color code for "CROSS OVER CABLE" as shown.
 It is not the same as a standard Cat 5 patch cabling. The outer cable jacket should
 Be "Orange" in color. This is not a straight thru pin 1 to pin 1 cable.

Figure 24: RJ-45 8P8C Cable for WattMaster Cross Over Networking - WattMaster Part #HZ000136

Appendix B - VCM-X Modular and WSHP N2 Parameters

NOTE: The following points for the VCM-X Modular and VCM-X WSHP Controllers are additional points. All points and property identifiers in the VCM-X Controller table (pages 27-32) also apply to the VCM-X Modular and VCM-X WSHP Controllers.

N2 Properties for VCM-X Modular

Parameter	Name	Object	Description	Limits	
Modulating Compressor 2	MdCmp2	AI: 206	Current position of the 2nd Stage of Compressor Modulation.		
Head Pressure 1	HdPr1	AI: 207	Head Pressure for 1st Compressor		
Head Pressure 2	HdPr2	AI: 208	Head Pressure for 2nd Compressor		
Condenser Fan 1	CdFan1	AI: 209	Condenser Fan 1 Signal Status		
Condenser Fan 2	CdFan2	AI: 210	Condenser Fan 2 Signal Status		
Remote VFD Reset	RmVFDPos	AO: 258	Remote VFD Position Reset	-1	100

N2 Properties for VCM-X WSHP (Tulsa)

Parameter	Name	Object	Description	Limits	
Modulating Compressor 2	MdCmp2	AI: 206	Current position of the 2nd Stage of Compressor Modulation.		
Head Pressure 1	HdPr1	AI: 207	Head Pressure for 1st Compressor		
Head Pressure 2	HdPr2	AI: 208	Head Pressure for 2nd Compressor		
Condenser Fan 1	CdFan1	AI: 209	Condenser Fan 1 Signal Status		
Condenser Fan 2	CdFan2	AI: 210	Condenser Fan 2 Signal Status		
Water Temp. A	WaterTpA	AI: 220	Current water temperature of refrigerant for System A.		
Water Temp. B	WaterTpB	AI: 221	Current water temperature of refrigerant for System B.		
Remote VFD Reset	RmVFDPos	AO: 258	Remote VFD Position Reset	-1	100

N2 Properties for VCM-X WSHP (Tulsa)

Parameter	Name	Object	Description	Limits	
Compressor A1 Low Suction Pressure Alarm	A1LSPAIm	BI: 222	Alarm that indicates Suction Pressure for Compressor A1 is below the Low Suction Pressure Cooling (Heating) Setpoint.		
Compressor A1 Lockout Alarm	A1LktAlm	BI: 223	Alarm that indicates Compressor A1 is locked out.		
Compressor A2 Low Suction Pressure Alarm	A2LSPAIm	BI: 224	Alarm that indicates Suction Pressure for Compressor A2 is below the Low Suction Pressure Cooling (Heating) Setpoint.		
Compressor A2 Lockout Alarm	A2LktAlm	BI: 225	Alarm that indicates Compressor A2 is locked out.		
Compressor B1 Low Suction Pressure Alarm	B1LSPAIm	BI: 226	Alarm that indicates Suction Pressure for Compressor B1 is below the Low Suction Pressure Cooling (Heating) Setpoint.		
Compressor B1 Lockout Alarm	B1LktAlm	BI: 227	Alarm that indicates Compressor B1 is locked out.		
Compressor B2 Low Suction Pressure Alarm	B2LSPAIm	BI: 228	Alarm that indicates Suction Pressure for Compressor B2 is below the Low Suction Pressure Cooling (Heating) Setpoint.		
Compressor 4 Lockout Alarm	B2LktAlm	BI: 229	Alarm that indicates Compressor B2 is locked out.		
Low Water Temperature 1 Alarm	LWT1Alm	BI: 230	Alarm that indicates water temperature is below the Leaving Water Safety Setpoint (Heating only) for System A.		

Appendix B - VCM-X Modular and WSHP N2 Parameters

N2 Properties for VCM-X WSHP (Tulsa)					
Parameter	Name	Object	Description	Limits	
Low Water Temperature 2 Alarm	LWT2Alm	BI: 231	Alarm that indicates water temperature is below the Leaving Water Safety Setpoint (Heating only) for System B		
Proof of Water 1 Flow Alarm	POWF1Alm	BI: 232	Alarm that indicates no Proof of Water Flow for System A (A1/A2)		
Proof of Water 2 Flow Alarm	POWF2Alm	BI: 233	Alarm that indicates no Proof of Water Flow for System B (B1/B2)		
Module Communications Alarm	ComMAlm	BI: 234	Alarm that indicates that one or more Modules are not communicating with the VCM-X WSHP Controller.		

N2 Properties for VCM-X WSHP (Coil)					
Parameter	Name	Object	Description	Limits	
Compressor A Low Suction Pressure Alarm	A1LSPAIm	BI: 222	Alarm that indicates Suction Pressure for Circuit A is below the Low Suction Pressure Cooling (Heating) Setpoint.		
Compressor A Lockout Alarm	A1LktAlm	BI: 223	Alarm that indicates Circuit A Compressors are locked out.		
Compressor B Low Suction Pressure Alarm	B1LSPAIm	BI: 226	Alarm that indicates Suction Pressure for Circuit B is below the Low Suction Pressure Cooling (Heating) Setpoint.		
Compressor B Lockout Alarm	B1LktAlm	BI: 227	Alarm that indicates Circuit B Compressors are locked out.		
Low Water Temperature Alarm	LWT1Alm	BI: 230	Alarm that indicates water temperature is below the Leaving Water Safety Setpoint (Heating only).		
Proof of Water Flow Alarm	POWF1Alm	BI: 232	Alarm that indicates no Proof of Water Flow.		
Module Communications Alarm	ComMAlm	BI: 234	Alarm that indicates that one or more Modules are not communicating with the VCM-X WSHP Controller.		

N2 Properties for VCM-X WSHP (Coil)					
Parameter	Name	Object	Description	Limits	
Modulating Compressor 2	MdCmp2	AI: 206	Current position of the 2nd Stage of Compressor Modulation.		
Head Pressure 1	HdPr1	AI: 207	Head Pressure for 1st Compressor		
Head Pressure 2	HdPr2	AI: 208	Head Pressure for 2nd Compressor		
Condenser Fan 1	CdFan1	AI: 209	Condenser Fan 1 Signal Status		
Condenser Fan 2	CdFan2	AI: 210	Condenser Fan 2 Signal Status		
Water Temp. A	WaterTpA	AI: 220	Current water temperature.		
Remote VFD Reset	RmVFDPos	AO: 258	Remote VFD Position Reset	-1	100

Appendix C - VCM-X N2 Parameters

N2 Properties for the VCM-X Controller				
Parameter	Name	Object	Description	Limits
Alarm Status	AlrmSts	AI: 1	Needed only in legacy application.	
Control Status	CtrlSts	AI: 4	Current operational status.	
Occupied/ Mode Enable Cooling Setpoint Mirror	CISt	AI: 7	Occupied/ Mode Enable Cooling Setpoint Mirror.	
Control Temperature	CtrlTp	AI: 9	Current value of the control temperature sensor.	
Duct Static Pressure	DuctPr	AI: 14	Current value of the duct static pressure sensor.	
Economizer Position	EcoPos	AI: 16	Current position of the economizer damper.	
Occupied/ Mode Enable Heating Setpoint Mirror	HtSt	AI: 31	Occupied/ Mode Enable Heating Setpoint Mirror.	
Modulating Gas Valve Position	MdHt-2Pos	AI: 38	Current position of MODGAS II modulating gas valve control.	
On Board Relays	OnRlys	AI: 44	Needed only in legacy application.	
Outdoor Air Dewpoint	OaDwpt	AI: 47	Current calculated outdoor air dewpoint added on version 1.09.	
Outdoor Air Humidity	OaRh	AI: 52	Current value of the outdoor humidity sensor.	
Outdoor Air Temperature	OaTp	AI: 54	Current value of the outdoor temperature sensor.	
Outdoor Air Wetbulb	OaWtbl	AI: 55	Current calculated value of the outdoor wetbulb temperature.	
Reheat Value Position	Rt2Pos	AI: 60	Current position of MHGRV modulating hot gas reheat valve control.	
Relief Pressure	RfPr	AI: 62	Current value of the building pressure sensor.	
Return Air Temperature	RaTp	AI: 64	Current value of the return temperature sensor.	
Indoor Humidity	InRh	AI: 67	Current value of the indoor humidity sensor.	

N2 Properties for the VCM-X Controller				
Parameter	Name	Object	Description	Limits
Space Temperature	SpcTp	AI: 72	Current value of the space temperature sensor.	
Current Supply Air Setpoint	SaTpStM	AI: 82	Current SAT Cooling or Heating setpoint if there is no reset source; Current calculated SAT setpoint with Reset Source.	
Supply Air Temperature	SaTp	AI: 83	Current value of the supply air temperature sensor.	
Temperature Demand	TpDmnd	AI: 84	Based on the comparison between the current Control Temperature and the Heating or Cooling Setpoint Temperatures. Does not work for supply air control	
VFD Blower Fan	VfdBw-Pos	AI: 88	Current position of the VFD blower fan signal.	
VFD Relief Fan	VfdExPos	AI: 89	Current position of the VFD relief fan signal.	
Application Software Version	AppVer	AI: 99	Current version of the software in the unit.	
Alarm Group 1	AlrmGrp1	AI: 104	Needed only in legacy application.	
Alarm Group 2	AlrmGrp2	AI: 105	Needed only in legacy application.	
Alarm Group 3	AlrmGrp3	AI: 106	Needed only in legacy application.	
Dewpoint Setpoint Mirror	DptStM	AI: 110	Mirror of the DPTSt "read only."	
External Relays 1-2	ExRlys12	AI: 111	Needed only in legacy application.	
External Relays 3-4	ExRlys34	AI: 112	Needed only in legacy application.	
Indoor Rh Setpoint Mirror	InRhStM	AI: 114	Mirror of the InRhSt "read only."	
Modulating Cool Position	MdCIPos	AI: 115	Current position of the modulating cooling signal (Chilled water or digital compressor).	
Modulating Heat Position	MdHtPos	AI: 116	Current position of the modulating heating signal (hot water or SCR heat).	

Appendix C - VCM-X N2 Parameters

N2 Properties for the VCM-X Controller					
Parameter	Name	Object	Description	Limits	
Unit Mode	UnitMode	AI: 123	Needed only in legacy application.		
Return Air CO ₂ Level	CO2Level	AI: 150	Current value of the CO ₂ sensor.		
Bypass Damper Position	ByPas-Dmp	AI: 153	Current position of the bypass damper signal.		
Return Damper Position	RaDmp	AI: 154	Current position of the return damper signal.		
Coil Temperature	CoilTp	AI: 181	Current coil temperature reading added on version 1.09.		
Outdoor Air CFM	OaCFM	AI: 193	Current Outdoor Airflow Measurement		
Exhaust CFM	EtCFM	AI: 194	Current Exhaust Airflow Measurement		
Supply Air CFM	SaCFM	AI: 195	Current Supply Airflow Measurement		
Current Calculated OA CFM setpoint	OACfm-StM	AI: 205	Current calculated Outdoor Air CFM based on CO ₂ level.		
Dewpoint Setpoint	DptSt	AO: 13	If the outdoor dewpoint rises above this setpoint, the unit will activate the Dehumidification Demand.	35	80
Occupied/ Mode Enable Cooling Setpoint	OcpClSt	AO: 42	If the control temperature rises one degree above this setpoint, the control will activate the cooling demand. If the control temperature is the Supply Air Sensor, then the cooling demand is always active.	0	99
Occupied/ Mode Enable Heating Setpoint	OcpHtSt	AO: 43	If the control temperature drops one degree below this setpoint, the control will activate the heating demand. If the control temperature is the Supply Air Sensor, then there is no heating demand.		99

N2 Properties for the VCM-X Controller					
Parameter	Name	Object	Description	Limits	
Outdoor Air Sensor Offset	OaTpOst	AO: 53	If the Outdoor Temperature Sensor is reading incorrectly, you can use this option to enter an offset temperature to adjust the Sensor's Temperature.	-100	100
Return Air Sensor Offset	RaTpOst	AO: 65	If the Return Temperature Sensor is reading incorrectly, you can use this option to enter an offset temperature to adjust the Sensor's Temperature.	-100	100
Schedule Force	SchdFrc	AO: 66	0 = Auto/ 1 = Forced On 2 = Forced Off	0	2
Space Sensor Offset	SpcTpOst	AO: 71	If the Space Temperature Sensor is reading incorrectly, you can use this option to enter an offset temperature to adjust the Sensor's Temperature.	-100	100
SAT Cooling Setpoint	SaClSt	AO: 77	Supply Air Setpoint in Cooling Mode.	40	80
SAT Heating Setpoint	SaHtSt	AO: 78	Supply Air Setpoint in Heating Mode.	40	200
Supply Air Sensor Offset	SaTpOst	AO: 80	If the Supply Air Temperature Sensor is reading incorrectly, you can use this option to enter an offset temperature to adjust the Sensor's Temperature.	-100	100
Warm Up Setpoint	WmupSt	AO: 91	In a VAV application, upon entering the occupied mode, the Warm-up Demand will be activated if the return air temperature falls one degree below this setpoint.	50	90

Appendix C - VCM-X N2 Parameters

N2 Properties for the VCM-X Controller					
Parameter	Name	Object	Description	Limits	
Wet Bulb Setpoint	WtblSt	AO: 92	The economizer is enabled if the outdoor temperature or wetbulb falls below this setpoint.	0	80
Coil Temperature Setpoint	CoilTpSt	AO: 107	This is the coil suction temperature target during dehumidification mode. Produces dewpoint in the supply air approximately 10°F above this setpoint.	35	70
Relief Pressure Setpoint	RfPrSt	AO: 118	This is the target building pressure to be maintained by the VFD Relief signal.	-0.2	0.2
Indoor Humidity Setpoint	InRhSt	AO: 120	If the indoor humidity rises above this setpoint, the unit will activate the Dehumidification Demand.	0	100
Unoccupied Cooling Offset	UnClOst	AO: 124	During the Unoccupied Mode of Operation, this Setpoint spreads the Occupied Cooling Setpoint out by a user adjustable amount. If you do not want Cooling to operate during the Unoccupied Mode, use the default setting of 30°F for these setpoints.	0	30
Unoccupied Heating Offset	UnHtOst	AO: 125	During the Unoccupied Mode of Operation, this Setpoint spreads the Occupied Heating Setpoint out by a user adjustable amount. If you do not want Heating to operate during the Unoccupied Mode, use the default setting of 30°F for these setpoints.	0	30

N2 Properties for the VCM-X Controller					
Parameter	Name	Object	Description	Limits	
CO ₂ Setpoint	CO2St	AO: 149	When the CO ₂ level rises above the CO ₂ Protection Limit Max Level, the Economizer's Minimum Position will begin to reset open proportionally between the CO ₂ Protection Limit Max Level Setpoint and the Reset Range Setpoint.	0	3000
Minimum Outside Air Setpoint	MinEcoSt	AO: 151	This is the minimum position of the economizer in the occupied modes.	1	100
Static Pressure Setpoint	DuctPrSt	AO: 152	This is the target duct pressure to be maintained by the VFD blower signal.	0.01	3
Preheater Setpoint	PreHtSp	AO: 196	Low Outside Air Ambient Protection Setpoint	0	100
Outdoor Air CFM Setpoint	OACfmSt	AO: 203	Minimum desired Outdoor Air CFM.	0.10 K	200 K
Outdoor Air CFM Reset Limit	OACfmRs	AO: 204	Maximum desired Outdoor Air CFM when CO ₂ reaches its reset limit.	0.10 K	200 K

Appendix C - VCM-X N2 Parameters

N2 Properties for the VCM-X Controller				
Parameter	Name	Object	Description	Limits
Bad Supply Air Sensor	SaTpAlm	BI: 2	Alarm that indicates a failure in the supply air sensor.	
CO ₂ Sensor Installed	CO2Cfg	BI: 3	Status that indicates the CO ₂ function has been configured.	
Cooling Enabled	ClEnbl	BI: 6	Status that indicates mechanical cooling is enabled.	
Economizer Enabled	EcoEnbl	BI: 15	Status that indicates the economizer is enabled.	
Fan Start Up Delay	FanDly	BI: 25	Status that indicates the fan is commanded to run, but it is in the start up delay mode.	
Fan Proving Alarm	PofAlm	BI: 26	Alarm that indicates a failure in the flow of the VFD blower.	
Heating Enabled	HtEnbl	BI: 30	Status that indicates that mechanical heating is enabled.	
High Supply Air Temperature Alarm	HiSaAlm	BI: 33	The Supply Air has risen above the Hi SAT Cutoff Setpoint. Heating stages begin to deactivate and the fan continues to run.	
Low Supply Air Temperature Alarm	LoSaAlm	BI: 37	The Supply Air has fallen below the Hi SAT Cutoff Setpoint and cooling stages will begin to deactivate. If the unit is in Economizer, Vent, or Heating Mode the Supply Fan will shut off.	
MODGAS II Connected	MdHt2Ins	BI: 39	Status that indicates the MODGAS II controller is connected.	
Proof of Flow Configured	PofCfg	BI: 57	Status that indicates the proof of flow function has been configured.	
REHEAT II Connected	Rt2Ins	BI: 58	Status that indicates the MHGRV controllers is connected to the system.	

N2 Properties for the VCM-X Controller				
Parameter	Name	Object	Description	Limits
Mechanical Cooling Alarm	MchClAlm	BI: 94	Compressor Relays are enabled but the Supply Air Temperature has not fallen 5°F w/in a user-adjustable time period. This does not indicate compressors are active and will not shut the unit down.	
Mechanical Heating Alarm	MchHtAlm	BI: 95	Heating Mode has been initiated but the Supply Air Temperature has not risen 5°F w/in a user-adjustable time period. This does not indicate heat stages are active and will not shut the unit down.	
Dirty Filter Detected	DrtFlAlm	BI: 96	Alarm that indicates the filters are dirty.	
Control Temperature Cool Failure	CtrlTpCF	BI: 108	This alarm is activated if the control temperature does not get within 5°F to the occupied cooling setpoint in an hour in the cooling mode. This alarm is not used in 100% outside air units or supply air control.	
Control Temperature Heat Failure	CtrlTpHF	BI: 109	This alarm is activated if the control temperature does not get within 5°F to the occupied heating setpoint in an hour in the heating mode. This alarm is not used in 100% outside air units or supply air control.	
Outdoor Air Temperature Lost	OaTpAlm	BI: 117	Alarm that indicates a failure in the outdoor air temperature.	
Smoke Detected Alarm	SmokeAlm	BI: 119	Alarm that indicates the Smoke sensor has been activated.	
Space Temperature Sensor Lost	SpcTpAlm	BI: 101	Alarm that indicates a failure in the space temperature sensor.	

Appendix C - VCM-X N2 Parameters

N2 Properties for the VCM-X Controller

Parameter	Name	Object	Description	Limits
On Board Relay 1	OnRly1	BI: 127	Current status of relay 1.	
On Board Relay 2	OnRly2	BI: 128	Current status of relay 2.	
On Board Relay 3	OnRly3	BI: 129	Current status of relay 3.	
On Board Relay 4	OnRly4	BI: 130	Current status of relay 4.	
On Board Relay 5	OnRly5	BI: 131	Current status of relay 5.	
Expansion Relay 1	ExRly1	BI: 133	Current status of relay 6.	
Expansion Relay 2	ExRly2	BI: 134	Current status of relay 7.	
Expansion Relay 3	ExRly3	BI: 135	Current status of relay 8.	
Expansion Relay 4	ExRly4	BI: 136	Current status of relay 9.	
Expansion Relay 5	ExRly5	BI: 137	Current status of relay 10.	
Expansion Relay 6	ExRly6	BI: 138	Current status of relay 11.	
Expansion Relay 7	ExRly7	BI: 139	Current status of relay 12.	
Expansion Relay 8	ExRly8	BI: 140	Current status of relay 13.	
Expansion Relay 9	ExRly9	BI: 141	Current status of relay 14.	
Expansion Relay 10	ExRly10	BI: 142	Current status of relay 15.	
Expansion Relay 11	ExRly11	BI: 143	Current status of relay 16.	
Expansion Relay 12	ExRly12	BI: 144	Current status of relay 17.	
Expansion Relay 13	ExRly13	BI: 145	Current status of relay 18.	
Expansion Relay 14	ExRly14	BI: 146	Current status of relay 19.	
Expansion Relay 15	ExRly15	BI: 147	Current status of relay 20.	
Expansion Relay 16	ExRly16	BI: 148	Current status of relay 21.	

VCM-X PT-Link II N2®

Property Identifier:

The PT-Link II N2® Link amends the following property identity to the N2® property identifier.

N2PropertyIdentifier :

WattN2ScheduleForce ::= ENUMERATED {

NormalOperation (0),
ForceOccupied (1),
ForceUnoccupied (2)
}

VcmxUnitMode ::= ENUMERATED {

Unoccupied (0),
RemoteContactOccupied (1),
NormalScheduleOccupied (2),
PushButtonOrZoneOverride (3),
HolidayModeActive (4),
UnoccupiedZoneDemand (5),
RemoteScheduleOverride (6),
CurrentOutputForceMode (7),
SATHighOrLowCutOff (8),
CO2OverrideInProgress (9),
PurgeModeActive (10)
}

VcmxControlStatusBits ::= ENUMERATED {

Off (0),
Vent (1),
Cool (2),
Heat (3),
Dehum (4),
Dehum Cool (5),
Dehum Heat (6),
Warm Up Mode (7)
}

VcmxOnBoardRelaysBits ::= BIT STRING {

OnBoardRelay1 (0),
OnBoardRelay2 (1),
OnBoardRelay3 (2),
OnBoardRelay4 (3),
OnBoardRelay5 (4)
}

Appendix C - VCM-X N2 Parameters

VcmxExternal Relays1-2Bits ::= BIT STRING {

```

ExpansionBoard1Relay1      (0),
ExpansionBoard1Relay2      (1),
ExpansionBoard1Relay3      (2),
ExpansionBoard1Relay4      (3),
ExpansionBoard2Relay1      (4),
ExpansionBoard2Relay2      (5),
ExpansionBoard2Relay3      (6),
ExpansionBoard2Relay4      (7)
}

```

VcmxExternal Relays2-4Bits ::= BIT STRING {

```

ExpansionBoard3Relay1      (0),
ExpansionBoard3Relay2      (1),
ExpansionBoard3Relay3      (2),
ExpansionBoard3Relay4      (3),
ExpansionBoard4Relay1      (4),
ExpansionBoard4Relay2      (5),
ExpansionBoard4Relay3      (6),
ExpansionBoard4Relay4      (7)
}

```

VcmxAlarmStatusBits ::= BIT STRING {

```

Alarm Group1               (0),
Alarm Group2               (1),
Alarm Group3               (2)
}

```

VcmxAlarmGroup1Bits ::= BIT STRING {

```

SupplyTempSensorFailure    (0),
LostOutdoorTempSensorSignal (1),
LostSpaceTempSensorSignal  (2)
}

```

VcmxAlarmGroup2Bits ::= BIT STRING {

```

MechanicalCoolingAlarm     (0),
MechanicalHeatingAlarm     (1),
FanProvingAlarm            (2),
DirtyFilterDetected        (3),
SmokeDetected              (4)
}

```

VcmxAlarmGroup3Bits ::= BIT STRING {

```

LowSupplyAirTempAlarm      (0),
HighSupplyAirTempAlarm    (1),
LowControlTempAlarm        (2),
HighControlTempAlarm      (3)
}

```

Appendix D - SA Controller N2 Parameters

N2 Properties for SA Controller				
Parameter	Name	Object	Description	Limits
Control Status	CtrlSts	AI: 4	Current operational status.	
Occupied/ Mode Enable Cooling Setpoint Mirror	CISt	AI: 7	Occupied/ Mode Enable Cooling Setpoint Mirror.	
Control Temperature	CtrlTp	AI: 9	Current value of the control temperature sensor.	
Duct Static Pressure	DuctPr	AI: 14	Current value of the duct static pressure sensor.	
Economizer Position	EcoPos	AI: 16	Current position of the economizer damper.	
Occupied/ Mode Enable Heating Setpoint Mirror	HtSt	AI: 31	Occupied/ Mode Enable Heating Setpoint Mirror.	
Modulating Gas Valve Position	MdHt-2Pos	AI: 38	Current position of MODGAS II modulating gas valve control.	
Reheat Value Position	Rt2Pos	AI: 60	Current position of MHGRV modulating hot gas reheat valve control.	
Indoor Humidity	InRh	AI: 67	Current value of the indoor humidity sensor.	
Space Temperature	SpcTp	AI: 72	Current value of the space temperature sensor.	
Current Supply Air Setpoint	SaTpStM	AI: 82	Current SAT Cooling or Heating setpoint if there is no reset source; Current calculated SAT setpoint with Reset Source.	
Supply Air Temperature	SaTp	AI: 83	Current value of the supply air temperature sensor.	
Temperature Demand	TpDmnd	AI: 84	Based on the comparison between the current Control Temperature and the Heating or Cooling Setpoint Temperatures. Does not work for supply air control	
VFD Blower Fan	VfdBw-Pos	AI: 88	Current position of the VFD blower fan signal.	

N2 Properties for SA Controller				
Parameter	Name	Object	Description	Limits
Application Software Version	AppVer	AI: 99	Current version of the software in the unit.	
Coil Temperature Setpoint	CoilTpSt	AI: 107	Current Coil Temperature Setpoint.	
Dewpoint Setpoint Mirror	DptStM	AI: 110	Mirror of the DPtSt "read only."	
Indoor RH Setpoint Mirror	InRhStM	AI: 114	Mirror of the InRhSt "read only."	
Modulating Cool Position	MdClPos	AI: 115	Current position of the modulating cooling signal (Chilled water or digital compressor).	
Modulating Heat Position	MdHtPos	AI: 116	Current position of the modulating heating signal (hot water or SCR heat).	
Unit Mode	UnitMode	AI: 123	Needed only in legacy application.	
Coil Temperature	CoilTp	AI: 181	Current coil temperature reading added on version 1.09.	
Modulating Compressor 2 Position	MdCmp2	AI: 206	Current position of the 2nd Stage of Compressor Modulation.	
Head Pressure 1	HdPr1	AI: 207	Head Pressure for 1st unit.	
Head Pressure 2	HdPr2	AI: 208	Head Pressure for 2nd unit.	
Entering Air Temperature	EaTp	AI: 235	Temperature of the air that is entering the unit.	
Entering Water Temperature	EwTp	AI: 236	Temperature of the water that is entering the unit.	
Entering Air Humidity	EaRh	AI: 237	Relative Humidity of the Entering Air.	
Coil Temperature 2	CoilTp2	AI: 240	Current Coil Temperature for 2nd unit.	
Entering Air Dewpoint	EaDpt	AI: 241	Current Entering Air Dewpoint	
Water Side Economizer Bypass	WSEByp	AI: 242	Current Water Side Economizer Bypass Position for 1st unit.	
Water Side Economizer Bypass 2	WSEByp2	AI: 243	Current Water Side Economizer Bypass Position for 2nd unit.	
Condenser Position 1	CdPos1	AI: 246	Current Condenser Position for 1st unit.	

Appendix D - SA Controller N2 Parameters

N2 Properties for SA Controller					
Parameter	Name	Object	Description	Limits	
Condenser Position 2	CdPos2	AI: 247	Current Condenser Position for 2nd unit.		
Dewpoint Setpoint	DptSt	AO: 13	If the outdoor dewpoint rises above this setpoint, the unit will activate the Dehumidification Demand.	35	80
Occupied/ Mode Enable Cooling Setpoint	OcpClSt	AO: 42	If the control temperature rises one degree above this setpoint, the control will activate the cooling demand. If the control temperature is the Supply Air Sensor, then the cooling demand is always active.	0	99
Occupied/ Mode Enable Heating Setpoint	OcpHtSt	AO: 43	If the control temperature drops one degree below this setpoint, the control will activate the heating demand. If the control temperature is the Supply Air Sensor, then there is no heating demand.		99
Schedule Force	SchdFrc	AO: 66	0 = Auto/ 1 = Forced On 2 = Forced Off	0	2
Space Sensor Offset	SpcTpOst	AO: 71	If the Space Temperature Sensor is reading incorrectly, you can use this option to enter an offset temperature to adjust the Sensor's Temperature.	-100	100
SAT Cooling Setpoint	SaClSt	AO: 77	Supply Air Setpoint in Cooling Mode.	40	80
SAT Heating Setpoint	SaHtSt	AO: 78	Supply Air Setpoint in Heating Mode.	40	200

N2 Properties for SA Controller					
Parameter	Name	Object	Description	Limits	
Supply Air Sensor Offset	SaTpOst	AO: 80	If the Supply Air Temperature Sensor is reading incorrectly, you can use this option to enter an offset temperature to adjust the Sensor's Temperature.	-100	100
Warm Up Setpoint	WmupSt	AO: 91	In a VAV application, upon entering the occupied mode, the Warm-up Demand will be activated if the return air temperature falls one degree below this setpoint.	50	90
Coil Temperature Setpoint	CoilTpSt	AO: 107	This is the coil suction temperature target during dehumidification mode. Produces dewpoint in the supply air approximately 10°F above this setpoint.	35	70
Indoor Humidity Setpoint	InRhSt	AO: 120	If the indoor humidity rises above this setpoint, the unit will activate the Dehumidification Demand.	0	100
Unoccupied Cooling Offset	UnClOst	AO: 124	During the Unoccupied Mode of Operation, this Setpoint spreads the Occupied Cooling Setpoint out by a user adjustable amount. If you do not want Cooling to operate during the Unoccupied Mode, use the default setting of 30°F for these setpoints.	0	30

Appendix D - SA Controller N2 Parameters

N2 Properties for SA Controller					
Parameter	Name	Object	Description	Limits	
Unoccupied Heating Offset	UnHtOst	AO: 125	During the Unoccupied Mode of Operation, this Setpoint spreads the Occupied Heating Setpoint out by a user adjustable amount. If you do not want Heating to operate during the Unoccupied Mode, use the default setting of 30°F for these setpoints.	0	30
Static Pressure Setpoint	DuctPrSt	AO: 152	This is the target duct pressure to be maintained by the VFD blower signal.	0.01	3
Preheater Setpoint	PreHtSp	AO: 196	Low Outside Air Ambient Protection Setpoint	0	100
Entering Air Offset Setpoint	EaTpOst	AO: 238	If the Entering Air Temperature Sensor is reading incorrectly, you can use this option to enter an offset temperature to adjust the Sensor's Temperature.		
Entering Water Offset Setpoint	EwTpOst	AO: 239	If the Entering Water Temperature Sensor is reading incorrectly, you can use this option to enter an offset temperature to adjust the Sensor's Temperature.		

N2 Properties for SA Controller			
Parameter	Name	Object	Description
Bad Supply Air Sensor	SaTpAlm	BI: 2	Alarm that indicates a failure in the supply air sensor.
Cooling Enabled	ClEnbl	BI: 6	Status that indicates mechanical cooling is enabled.
Economizer Enabled	EcoEnbl	BI: 15	Status that indicates the economizer is enabled.
Fan Start Up Delay	FanDly	BI: 25	Status that indicates the fan is commanded to run, but it is in the start up delay mode.
Fan Proving Alarm	PofAlm	BI: 26	Alarm that indicates a failure in the flow of the VFD blower.
Heating Enabled	HtEnbl	BI: 30	Status that indicates that mechanical heating is enabled.
High Supply Air Temperature Alarm	HiSaAlm	BI: 33	The Supply Air has risen above the Hi SAT Cutoff Setpoint. Heating stages begin to deactivate and the fan continues to run.
Low Supply Air Temperature Alarm	LoSaAlm	BI: 37	The Supply Air has fallen below the Hi SAT Cutoff Setpoint and cooling stages will begin to deactivate. If the unit is in Economizer, Vent, or Heating Mode the Supply Fan will shut off.
MODGAS II Connected	MdHt2Ins	BI: 39	Status that indicates the MODGAS II controller is connected.
REHEAT II Connected	Rt2Ins	BI: 58	Status that indicates the MHGRV controllers is connected to the system.
Mechanical Cooling Alarm	MchClAlm	BI: 94	Compressor Relays are enabled but the Supply Air Temperature has not fallen 5°F w/in a user-adjustable time period. This does not indicate compressors are active and will not shut the unit down.

Appendix D - SA Controller N2 Parameters

N2 Properties for SA Controller			
Parameter	Name	Object	Description
Mechanical Heating Alarm	MchHtAlm	BI: 95	Heating Mode has been initiated but the Supply Air Temperature has not risen 5°F w/in a user-adjustable time period. This does not indicate heat stages are active and will not shut the unit down.
Dirty Filter Detected	DrtFlAlm	BI: 96	Alarm that indicates the filters are dirty.
Control Temperature Cool Failure	CtrlTpCF	BI: 108	This alarm is activated if the control temperature does not get within 5°F to the occupied cooling setpoint in an hour in the cooling mode. This alarm is not used in 100% outside air units or supply air control.
Control Temperature Heat Failure	CtrlTpHF	BI: 109	This alarm is activated if the control temperature does not get within 5°F to the occupied heating setpoint in an hour in the heating mode. This alarm is not used in 100% outside air units or supply air control.
Space Temperature Sensor Lost	SpcTpAlm	BI: 101	Alarm that indicates a failure in the space temperature sensor.
On Board Relay 1	OnRly1	BI: 127	Current status of relay 1.
On Board Relay 2	OnRly2	BI: 128	Current status of relay 2.
On Board Relay 3	OnRly3	BI: 129	Current status of relay 3.
On Board Relay 4	OnRly4	BI: 130	Current status of relay 4.
On Board Relay 5	OnRly5	BI: 131	Current status of relay 5.
Expansion Relay 1	ExRly1	BI: 133	Current status of relay 6.
Expansion Relay 2	ExRly2	BI: 134	Current status of relay 7.
Expansion Relay 3	ExRly3	BI: 135	Current status of relay 8.
Expansion Relay 4	ExRly4	BI: 136	Current status of relay 9.
Expansion Relay 5	ExRly5	BI: 137	Current status of relay 10.
Expansion Relay 6	ExRly6	BI: 138	Current status of relay 11.
Expansion Relay 7	ExRly7	BI: 139	Current status of relay 12.
Expansion Relay 8	ExRly8	BI: 140	Current status of relay 13.
Expansion Relay 9	ExRly9	BI: 141	Current status of relay 14.
Expansion Relay 10	ExRly10	BI: 142	Current status of relay 15.

N2 Properties for SA Controller			
Parameter	Name	Object	Description
Expansion Relay 11	ExRly11	BI: 143	Current status of relay 16.
Expansion Relay 12	ExRly12	BI: 144	Current status of relay 17.
Expansion Relay 13	ExRly13	BI: 145	Current status of relay 18.
Expansion Relay 14	ExRly14	BI: 146	Current status of relay 19.
Expansion Relay 15	ExRly15	BI: 147	Current status of relay 20.
Expansion Relay 16	ExRly16	BI: 148	Current status of relay 21.
Emergency Shutdown Alarm	EmerAlm	BI: 219	Alarm that indicates Emergency Shutdown.
Drain Pan Overflow	DrnAlm	BI: 244	Alarm that indicates overflow of the drain pan.
Proof of Water Flow Alarm	PoWFAlm	BI: 245	Alarm that indicates no Proof of Water Flow.
Entering Air Temperature Alarm	EaTpAlm	BI: 248	Alarm that indicates failure in the Entering Air Temperature Sensor.

SA Controller PT-Link II N2®
Property Identifier:

The PT-Link II N2® Link amends the following property identity to the N2® property identifier.

N2PropertyIdentifier :

```
VcmxControlStatusBits ::= ENUMERATED {
    Off (0),
    Vent (1),
    Cool (2),
    Heat (3),
    Dehum (4),
    Dehum Cool (5),
    Dehum Heat (6),
    Warm Up Mode (7)
}
```

Appendix E - VCM N2 Parameters

N2 Parameters for the VCM Controller				
Parameter	Name	Object	Description	Limits
Application Software Version	AppVer	AI: 99	Current version of the software in the unit.	
Alarm Status	AlrmSts	AI: 1	Needed only in legacy application.	
Unit Mode	UnitMode	AI: 123	Needed only in legacy application.	
Control Status	CtrlSts	AI: 4	Current operational status.	
Control Temperature	CtrlTp	AI: 9	Current value of the control temperature sensor.	
Occupied/ Mode Enable Cooling Setpoint Mirror	ClSt	AI: 7	Occupied/ Mode Enable Cooling Setpoint Mirror.	
Duct Static Pressure	DuctPr	AI: 14	Current value of the duct static pressure sensor.	
Economizer Position	EcoPos	AI: 16	Current position of the economizer damper.	
External Relays 1-2	ExRlys12	AI: 111	Needed only in legacy application.	
External Relays 3-4	ExRlys34	AI: 112	Needed only in legacy application.	
Indoor Humidity	InRh	AI: 67	Current value of the indoor humidity sensor.	
Occupied/ Mode Enable Heating Setpoint Mirror	HtSt	AI: 31	Occupied/ Mode Enable Heating Setpoint Mirror.	
On Board Relay	OnRlys	AI: 44	Needed only in legacy application.	
Outdoor Air Humidity	OaRh	AI: 52	Current value of the outdoor humidity sensor.	
Outdoor Air Temperature	OaTp	AI: 54	Current value of the outdoor temperature sensor.	
Outdoor Air Wetbulb	OaWtbl	AI: 55	Current calculated value of the outdoor wetbulb temperature.	
Relief Pressure	RfPr	AI: 62	Current value of the building pressure sensor.	
Return Air CO ₂ Level	CO2Level	AI: 150	Current value of the CO ₂ sensor.	
Return Air Temperature	RaTp	AI: 64	Current value of the return temperature sensor.	
Space Temperature	SpcTp	AI: 72	Current value of the space temperature sensor.	

N2 Parameters for the VCM Controller				
Parameter	Name	Object	Description	Limits
Supply Air Temperature	SaTp	AI: 83	Current value of the supply air temperature sensor.	
Temperature Demand	TpDmnd	AI: 84	Based on the comparison between the current Control Temperature and the Heating or Cooling Setpoint Temperatures. Does not work for supply air control.	
VFD Blower Fan	VfdBwPos	AI: 88	Current position of the VFD blower fan signal.	
VFD Relief Fan	VfdExPos	AI: 89	Current position of the VFD relief fan signal.	
Modulating Gas Valve Position	MdHt2Pos	AI: 38	Current position of MODGAS II modulating gas valve control.	
Reheat Value Position	Rt2Pos	AI: 60	Current position of MHGRV modulating hot gas reheat valve control.	
Alarm Group 1	AlrmGrp1	AI: 104	Needed only in legacy application.	
Alarm Group 2	AlrmGrp2	AI: 105	Needed only in legacy application.	
Alarm Group 3	AlrmGrp3	AI: 106	Needed only in legacy application.	
Dewpoint Setpoint Mirror	DptStM	AI: 110	Mirror of the DPTSt "read only."	
Indoor RH Setpoint Mirror	InRhStM	AI: 114	Mirror of the InRhSt "read only."	
Modulating Cool Position	MdClPos	AI: 115	Current position of the modulating cooling signal (Chilled water or digital compressor).	
Modulating Heat Position	MdHtPos	AI: 116	Current position of the modulating heating signal (hot water or SCR heat).	
Bypass Damper Position	ByPasDmp	AI: 153	Current position of the bypass damper signal.	

Appendix E - VCM N2 Parameters

N2 Parameters for the VCM Controller					
Parameter	Name	Object	Description	Limits	
Return Damper Position	RaDmp	AI: 154	Current position of the return damper signal.		
Outdoor Air Dew Point	OaDwpt	AI: 47	Current calculated outdoor air dewpoint added on version 1.09.		
Current Supply Air Setpoint	SaTpStM	AI: 82	SAT/Reset Current SAT Cooling or Heating setpoint if there is no reset source; Current calculated SAT setpoint with Reset Source.		
Coil Temperature	CoilTp	AI: 181	Current coil temperature reading added on version 1.09.		
Preheater Setpoint	PreHtSp	AO: 196	Low Outside Air Ambient Protection Setpoint	0	100
CO ₂ Setpoint	CO2St	AO: 149	When the CO ₂ level rises above the CO ₂ Protection Limit Max Level, the Economizer's Minimum Position will begin to reset open proportionally between the CO ₂ Protection Limit Max LevelSetpoint and the Reset Range Setpoint.	0	3000
Static Pressure Setpoint	DuctPrSt	AO: 152	This is the target duct pressure to be maintained by the VFD blower signal.	0.01	3
Minimum Outside Air Setpoint	MinEcoSt	AO: 151	This is the minimum position of the economizer in the occupied modes.	1	100
Occupied/ Mode Enable Cooling Setpoint	OcpClSt	AO: 42	If the control temperature rises one degree above this setpoint, the control will activate the cooling demand. If the control temperature is the Supply Air Sensor, then the cooling demand is always active.	0	99

N2 Parameters for the VCM Controller					
Parameter	Name	Object	Description	Limits	
Occupied/ Mode Enable Heating Setpoint	OcpHtSt	AO: 43	If the control temperature drops one degree below this setpoint, the control will activate the heating demand. If the control temperature is the Supply Air Sensor, then there is no heating demand.	0	99
Outdoor Air Sensor Offset	OaTpOst	AO: 53	If the Outdoor Temperature Sensor is reading incorrectly, you can use this option to enter an offset temperature to adjust the Sensor's Temperature.	-100	100
Relief Pressure Setpoint	RfPrSt	AO: 118	This is the target building pressure to be maintained by the VFD Relief signal.	-0.2	0.2
Return Air Sensor Offset	RaTpOst	AO: 65	If the Return Temperature Sensor is reading incorrectly, you can use this option to enter an offset temperature to adjust the Sensor's Temperature.	-100	100
Schedule Force	SchdFrc	AO: 66	0 = Auto/ Unoccupied Mode 1 = Forced On 2 = Forced Off	0	2
Space Sensor Offset	SpcTpOst	AO: 71	If the Space Temperature Sensor is reading incorrectly, you can use this option to enter an offset temperature to adjust the Sensor's Temperature.	-100	100
SAT/Reset Source Cooling Setpoint	SaClSt	AO: 77	Supply Air setpoint or Reset Source target temperature in Cooling Mode.	40	80
SAT/Reset Source Heating Setpoint	SaHtSt	AO: 78	Supply Air setpoint or Reset Source target temperature in Heating Mode.	40	200

Appendix E - VCM N2 Parameters

N2 Parameters for the VCM Controller					
Parameter	Name	Object	Description	Limits	
Supply Air Sensor Offset	SaTpOst	AO: 80	If the Supply Air Temperature Sensor is reading incorrectly, you can use this option to enter an offset temperature to adjust the Sensor's Temperature.	-100	100
Unoccupied Cooling Offset	UnClOst	AO: 124	During the Unoccupied Mode of Operation, this Setpoint spreads the Occupied Cooling Setpoint out by a user adjustable amount. If you do not want Cooling to operate during the Unoccupied Mode, use the default setting of 30°F for these setpoints.	0	30
Unoccupied Heating Offset	UnHtOst	AO: 125	During the Unoccupied Mode of Operation, this Setpoint spreads the Occupied Heating Setpoint out by a user adjustable amount. If you do not want Heating to operate during the Unoccupied Mode, use the default setting of 30°F for these setpoints.	0	30
Dewpoint Setpoint	DptSt	AO: 13	If the outdoor dewpoint rises above this setpoint, the unit will activate the Dehumidification Demand.	35	80
Coil Temperature Setpoint	CoilTpSt	AO: 107	This is the coil suction temperature target during dehumidification mode. Produces dewpoint in the supply air approximately 10°F above this setpoint.	35	70

N2 Parameters for the VCM Controller					
Parameter	Name	Object	Description	Limits	
Indoor Humidity Setpoint	InRhSt	AO: 120	If the indoor humidity rises above this setpoint, the unit will activate the Dehumidification Demand.	0	100
Warm Up Setpoint	WmupSt	AO: 91	In a VAV application, upon entering the occupied mode, the Warm-up Demand will be activated if the return air temperature falls one degree below this setpoint.	50	90
Wet Bulb Setpoint	WtblSt	AO: 92	The economizer is enabled if the outdoor temperature or wetbulb falls below this setpoint.	0	80
Bad Supply Air Sensor	SaTpAlm	BI: 2	Alarm that indicates a failure in the supply air sensor.		
CO ₂ Sensor Installed	CO2Cfg	BI: 3	Status that indicates the CO ₂ function has been configured.		
Cooling Demand	CIDmnd	BI: 5	Status that indicates a demand for cooling.		
Cooling Enabled	ClEnbl	BI: 6	Status that indicates mechanical cooling is enabled.		
Economizer Enabled	EcoEnbl	BI: 15	Status that indicates the economizer is enabled.		
Fan Start Up Delay	FanDly	BI: 25	Status that indicates the fan is commanded to run, but it is in the start up delay mode.		
Fan Proving Alarm	PofAlm	BI: 26	Alarm that indicates a failure in the flow of the VFD blower.		
Heating Demand	HtDmnd	BI: 29	Status that indicates a demand for heating.		
Heating Enabled	HtEnbl	BI: 30	Status that indicates that mechanical heating is enabled.		

Appendix E - VCM N2 Parameters

N2 Parameters for the VCM Controller				
Parameter	Name	Object	Description	Limits
High Supply Air Temperature Alarm	HiSaAlm	BI: 33	The Supply Air has risen above the Hi SAT Cutoff Setpoint. Heating stages begin to deactivate and the fan continues to run.	
Low Supply Air Temperature Alarm	LoSaAlm	BI: 37	The Supply Air has fallen below the Hi SAT Cutoff Setpoint and cooling stages will begin to deactivate. If the unit is in Economizer, Vent, or Heating Mode the Supply Fan will shut off.	
MODGAS II Connected	MdHt2Ins	BI: 39	Status that indicates the MODGAS II controller is connected.	
Proof of Flow Configured	PofCfg	BI: 57	Status that indicates the proof of flow function has been configured.	
REHEAT II Connected	Rt2Ins	BI: 58	Status that indicates the MHGRV controllers is connected to the system.	
Warm Up Mode Active	WmupDmnd	BI: 90	Status that indicates the control is in the Warm-up mode.	
Mechanical Cooling Alarm	MchClAlm	BI: 94	Compressor Relays are enabled but the Supply Air Temperature has not fallen 5°F w/in a user-adjustable time period. This does not indicate compressors are active and will not shut the unit down.	
Mechanical Heating Alarm	MchHtAlm	BI: 95	Heating Mode has been initiated but the Supply Air Temperature has not risen 5°F w/in a user-adjustable time period. This does not indicate heat stages are active and will not shut the unit down.	
Dirty Filter Detected	DrtFlAlm	BI: 96	Alarm that indicates the filters are dirty.	

N2 Parameters for the VCM Controller				
Parameter	Name	Object	Description	Limits
Control Temperature Cool Failure	CtrlTpCF	BI: 108	This alarm is activated if the control temperature does not get within 5°F to the occupied cooling setpoint in an hour in the cooling mode. This alarm is not used in 100% outside air units or supply air control.	
Control Temperature Heat Failure	CtrlTpHF	BI: 109	This alarm is activated if the control temperature does not get within 5°F to the occupied heating setpoint in an hour in the heating mode. This alarm is not used in 100% outside air units or supply air control.	
Dehumidification Demand	DehmDmnd	BI: 113	Status that indicates a demand for dehumidification.	
Outdoor Air Temperature Lost	OaTpAlm	BI: 117	Alarm that indicates a failure in the outdoor air temperature.	
Smoke Detected Alarm	SmokeAlm	BI: 119	Alarm that indicates the Smoke sensor has been activated.	
Space Temperature Sensor Lost	SpcTpAlm	BI: 101	Alarm that indicates a failure in the space temperature sensor.	
On Board Relay 1	OnRly1	BI: 127	Current status of relay 1.	
On Board Relay 2	OnRly2	BI: 128	Current status of relay 2.	
On Board Relay 3	OnRly3	BI: 129	Current status of relay 3.	
On Board Relay 4	OnRly4	BI: 130	Current status of relay 4.	
On Board Relay 5	OnRly5	BI: 131	Current status of relay 5.	
Expansion Relay 1	ExRly1	BI: 133	Current status of relay 6.	
Expansion Relay 2	ExRly2	BI: 134	Current status of relay 7.	
Expansion Relay 3	ExRly3	BI: 135	Current status of relay 8.	

N2 Parameters for the VCM Controller				
Parameter	Name	Object	Description	Limits
Expansion Relay 4	ExRly4	BI: 136	Current status of relay 9.	
Expansion Relay 5	ExRly5	BI: 137	Current status of relay 10.	
Expansion Relay 6	ExRly6	BI: 138	Current status of relay 11.	
Expansion Relay 7	ExRly7	BI: 139	Current status of relay 12.	
Expansion Relay 8	ExRly8	BI: 140	Current status of relay 13.	
Expansion Relay 9	ExRly9	BI: 141	Current status of relay 14.	
Expansion Relay 10	ExRly10	BI: 142	Current status of relay 15.	
Expansion Relay 11	ExRly11	BI: 143	Current status of relay 16.	
Expansion Relay 12	ExRly12	BI: 144	Current status of relay 17.	
Expansion Relay 13	ExRly13	BI: 145	Current status of relay 18.	
Expansion Relay 14	ExRly14	BI: 146	Current status of relay 19.	
Expansion Relay 15	ExRly15	BI: 147	Current status of relay 20.	
Expansion Relay 16	ExRly16	BI: 148	Current status of relay 21.	

VCM PT-Link II N2® Property Identifier:

The PT-Link II N2® Link amends the following property identity to the N2® property identifier.

N2PropertyIdentifier :

WattN2ScheduleForce ::= ENUMERATED {

```

NormalOperation           (0),
ForceOccupied             (1),
ForceUnoccupied           (2)
}

```

VcmUnitMode ::= ENUMERATED {

```

Unoccupied                (0),
RemoteContactOccupied     (1),
NormalScheduleOccupied    (2),
PushButtonOrZoneOverride  (3),
HolidayModeActive         (4),
UnoccupiedZoneDemand      (5),
RemoteScheduleOverride    (6),
CurrentOutputForceMode    (7),
SATHighOrLowCutOff        (8),
CO2OverrideInProgress     (9),
PurgeModeActive           (10)
}

```

VcmControlStatusBits ::= BIT STRING {

```

AhuControlEconomizer      (0),
NoOutdoorAirTempSensor    (1),
CarbonDioxideSensorPresent (2),
HeatCoolStagingDisabled   (3),
DehumidificationMode      (4),
ModGasIICConnected        (5),
ReheatIICConnected        (6)
}

```

Appendix E - VCM N2 Parameters

VcmOnBoardRelaysBits ::= BIT STRING {

```

OnBoardRelay1          (0),
OnBoardRelay2          (1),
OnBoardRelay3          (2),
OnBoardRelay4          (3),
OnBoardRelay5          (4)
}

```

VcmExternal Relays1-2Bits ::= BIT STRING {

```

ExpansionBoard1Relay1  (0),
ExpansionBoard1Relay2  (1),
ExpansionBoard1Relay3  (2),
ExpansionBoard1Relay4  (3),
ExpansionBoard2Relay1  (4),
ExpansionBoard2Relay2  (5),
ExpansionBoard2Relay3  (6),
ExpansionBoard2Relay4  (7)
}

```

VcmExternal Relays2-4Bits ::= BIT STRING {

```

ExpansionBoard3Relay1  (0),
ExpansionBoard3Relay2  (1),
ExpansionBoard3Relay3  (2),
ExpansionBoard3Relay4  (3),
ExpansionBoard4Relay1  (4),
ExpansionBoard4Relay2  (5),
ExpansionBoard4Relay3  (6),
ExpansionBoard4Relay4  (7)
}

```

VcmAlarmStatusBits ::= BIT STRING {

```

Alarm Group1           (0),
Alarm Group2           (1),
Alarm Group3           (2)
}

```

VcmAlarmGroup1Bits ::= BIT STRING {

```

SupplyTempSensorFailure (0),
LostOutdoorTempSensorSignal (1),
LostSpaceTempSensorSignal (2)
}

```

VcmAlarmGroup2Bits ::= BIT STRING {

```

MechanicalCoolingAlarm (0),
MechanicalHeatingAlarm (1),
FanProvingAlarm        (2),
DirtyFilterDetected    (3),
SmokeDetected          (4)
}

```

VcmAlarmGroup3Bits ::= BIT STRING {

```

LowSupplyAirTempAlarm (0),
HighSupplyAirTempAlarm (1),
LowControlTempAlarm   (2),
HighControlTempAlarm  (3)
}

```



Form: OR-PTLNK-II-N2-TGD-01E
All rights reserved.

Printed in the USA

August 2011
Copyright 2011

WattMaster Controls, Inc. • 8500 NW River Park Drive • Parkville, MO • 64152
Phone (816) 505-1100 www.orioncontrols.com Fax (816) 505-1101